

IDS-105GPP – Industrial Gigabit PoE Switch

 perle.com/products/5-port-industrial-gigabit-poe-switch.shtml

5 to 7 port Compact DIN Rail PoE Switch



- 5 port 10/100/1000Base-T (RJ45)
- 5 port 10/100/1000Base-T (RJ45) with 1 or 2 Gigabit fiber ports (SC/ST/SFP)
- 4 PoE/PoE+ PSE capable ports, fully compliant to IEEE 802.3af/at
- Hazardous Location and Industrial Control Equipment Certification
- Corrosion resistant IP30 aluminum case
- Redundant dual power input 24/48 VDC
- Overload current and reverse polarity protection
- Industrial operating temperature support up to -40 to 75C

Perle **Industrial-grade Ethernet Switches** are designed to stand up to **extreme temperatures, surges, vibrations, and shocks** found in **industrial automation, government, military, oil and gas, mining and outdoor applications**.

In addition, these PoE Switches are classified as **Power Sourcing Equipment (PSE)**. While using standard UTP cables that carry Ethernet data, the IDS-108FPP have **4 ports** that also **provide up to 30 watts of power** to Powered Devices (PDs) such as **wireless access points, Voice over IP phones and IP cameras**. Learn more [about PoE](#).

The **IDS-105GPP** is a **5 to 7 port Industrial Gigabit Ethernet** switch providing advanced performance enabling real-time deterministic network operation. It requires no configuration and will operate instantly as soon as you power it up.

IDS-105G are **rugged fan-less switches** that are hardened to provide superior reliability **in 0 to 60°C**, or harsh extended operating temperatures **from -40 to 75°C**. They come in a variety of models with 5 copper ports, 5 copper ports plus 1 fiber port or 5 copper ports plus 2 fiber ports.

Perle has been **designing industrial hardware** for serial ModBus and Profinet to Ethernet conversion environments **for over 35 years** and have used this expertise to design the **toughest Ethernet switches on the market**. Don't trust your critical communications to commercial switch products. Perle Industrial Ethernet switches give you proven assurance that your system will keep running for years to come.

IDS-105GPP Industrial Gigabit PoE Switch Features

Rugged design for harsh environments

- Corrosion resistant IP30 aluminum case
- UL508A Industrial Control Equipment Safety certified
- Hazardous locations - Class1/Div2, ATEX Class1/Zone2

Reliable operation

- Fan-less, no moving parts
 - Reverse polarity protection
 - Overload current protection
- Dual power input. Connect to separate power sources for redundancy.
- Handles vibration and shock conditions found in industrial environments

Real-time Ethernet performance

- Fast wire-speed , store and forward switching, non-blocking architecture
- Auto-sensing for speed and duplex
- Auto-mdi/mdix-crossover works with straight and crossover cables

PoE and PoE+ (on 4 ports)

Up to 30 Watts per port driving up to four class 4 (IEEE 802.3at Type 2) PDs

Input Voltage Booster

Voltage boost technology supports 24V power sources ensuring that a full and proper PSE voltage is provided across all PoE ports

Jumbo Frames

Supports Jumbo frames up to 10 KB

Energy Efficient Ethernet (EEE)

Energy Efficient Ethernet (EEE) as per 802.3az. This provides power savings during idle network activity.

Power

Dual Power Input Both inputs draw power simultaneously. If one power source fails, the other live source can, acting as a backup, supply enough power to meet the operational needs of the switch.

Flexible input voltage range : 24/48 VDC Nominal. (18 to 57 VDC)

Input Voltage Booster

Voltage boost technology supports 24V industrial power sources ensuring that a full and proper PSE voltage is available across all PoE ports

Power Connector

4-Pin Removable Terminal Block.
Grounding screw on metal chassis

Maximum Current Consumption @24 vDC

.27 Amps (No PoE PDs attached)
5.5 Amps (4 x PoE+)

Maximum Power Consumption @24 vDC

6 Watts (No PoE PDs attached)
132 Watts (4 x 30 Watts PoE+)

Overload Current Protection

Reset-able fuse provides overload current protection

Reverse polarity protection

Protection is provided should inputs be reversed.

Access Ports

RJ45

5 shielded RJ45 ports for 10/100/1000Base-T up to 100 meters (328 ft). 4 of these ports are PoE PSE capable
Auto-negotiation
Auto-MDI/MDIX-crossover for use with either crossover over straight-through cable types
Ethernet isolation 1500 V

PoE

4 PoE/PoE+ ports
Up to 30 Watts per port (@ switch RJ45) driving up to four class 4 (IEEE 802.3at Type 2) PDs

Small Form

1 or 2 empty SFP slot models for 1000Base-X SFP modules supplied by Perle, Cisco or other manufacturers of MSA

Factor compliant SFPs
Pluggable (SFP) slot(s)

Fixed Fiber port Fixed fiber port models
Duplex SC or ST connector Simplex (BIDI, single strand) SC connector PC and UPC type patch cords supported.

- Multimode 50/125 or 62.5/125 micron fiber cable
- Single mode 9/125 micron fiber cable

- Multimode 50/125 or 62.5/125 micron fiber cable
- Single mode 9/125 micron fiber cable

Fixed Fiber Port Specs	Fiber1 Type	Transmit (dBm)		Receive (dBm)		Power Budget (dB)	Wavelength (nm)	IEEE	Core Size (um)	Modal Bandwidth (MHz *Km)	Maximum Operating Distance
		Min	Max	Min	Max						
MMF (Duplex SC/ST)		-9.5	-4.0	-17.0	-3.0	7.5	850	1000Base-SX	62.5	160	220 m (722 ft)
									62.5	200	275 m (902 ft)
									50	400	500 m (1,640 ft)
									50	500	550 m (1,804 ft)
									50	2000	1000 m (3,281 ft)
MMF (Duplex SC/ST)		-6.0	0.0	-17.0	0.0	11.0	1310	1000Base-LX	62.5	160	2 km (1.2 mi)
									50	500	1 km (3,280 ft)
SMF (Duplex SC/ST)		-9.5	-3.0	-20.0	-3.0	10.5	1310	1000Base-LX/LH	9	**	10 km (6.2 mi)
SMF (Simplex SC)		-9.0	-3.0	-20.0	-3.0	11.0	1310 / 1490 / 1490 / 1310	1000Base-BX-U 1000Base-BX-D	9	**	10 km (6.2 mi)
SMF (Simplex SC)		-8.0	-3.0	-22.0	-3.0	14.0	1310 / 1490 / 1490 / 1310	1000Base-BX-U 1000Base-BX-D	9	**	20 km (12.4 mi)
SMF (Duplex SC/ST)		-2.0	2.0	-23.0	-3.0	21.0	1310	1000Base-EX	9	**	40 Km (24.9 mi)
SMF (Simplex)		-3.0	2.0	-23.0	-3.0	21.0	1310 / 1490 / 1490 / 1310	1000Base-BX-U	9	**	40 Km (24.9 mi)

SC)										
							1000Base-BX-D			
SMF (Duplex SC/ST)	-2.0	5.0	-23.0	-3.0	21.0	1550	1000Base-ZX	9	**	70 Km (43 mi)
SMF (Simplex SC)	-2.0	3.0	-26.0	-3.0	24.0	1510 / 1590 1590 / 1510	1000Base-BX-U 1000Base-BX-D	9	**	80 Km (50 mi)
SMF (Duplex SC/ST)	0.0	5.0	-32.0	-9.0	32.0	1550	1000Base-ZX	9	**	120 Km (74.6 mi)
SMF (Simplex SC)	-3.0	2.0	-34.0	-9.0	31.0	1510 / 1590 1590 / 1510	1000Base-BX-U 1000Base-BX-D	9	**	120 Km (74.6 mi)
SMF (Duplex SC/ST)	2.0	5.0	-34.0	-9.0	36.0	1550	1000Base-ZX	9	**	160 Km (100 mi)

* 1db/km multimode fiber cable

** as per ITU-T G.652 SMF specifications

Switch Properties

Standards

- IEEE 802.3 for 10Base-T
- IEEE 802.3u for 100Base-TX and 100Base-FX
- IEEE 802.3ab for 1000Base-T
- Energy Efficient Ethernet (EEE) as per 802.3az.
- IEEE 802.3x for Flow Control
- IEEE 802.3af Power Over Ethernet
- IEEE 802.3at Power Over Ethernet

Processing Type Store and Forward, non-blocking architecture

MAC Address Table Size 8K

Packet Buffer Memory 1 Mbit

Jumbo Frame Size 10 KB

Indicators

P1 This green LED is turned on when power is applied to the power #1 input

P2 This green LED is turned on when power is applied to the power #2 input

RJ45 Ethernet	These integrated colored LEDs indicate link, activity and speed for each port.
Fiber Link	Fiber link LED indicates Link and Data Activity

Environmental Specifications

Operating Temperature Ranges	Standard temperature models : 0° C to 60° C (32° F to 140° F). Industrial extended temperature models : -40° C to 75° C (-40 F to 167° F)
Storage Temperature Range	Minimum range of -25° C to 70° C (-13° F to 158° F). -40 C to 85 C (-40 F to 185 F) for industrial extended temperature models
Operating Humidity Range	5% to 90% non-condensing
Storage Humidity Range	5% to 95% non-condensing
Operating Altitude	Up to 3,048 meters (10,000 feet)
Chassis	Aluminum with an IP30 ingress protection rating
Din Rail Mountable	DIN Rail attachment included. Mounts to standard 35 mm DIN rail in accordance with DIN EN 60175. Removable to accommodate optional Panel/Wall mount kit
Maximum Heat Output	178 BTU/Hr
MTBF	648,530 hours (without fiber module) 492,890 hours (with fixed fiber module) 472,435 hours (with 1 SFP slot) 371,779 hours (with 2 SFP slots) <i>MTBF Calculation model based on MIL-HDBK-217-FN2 @ 30 °C</i>

Product Weight and Dimensions

Weight	0.37 Kg, 0.82 lbs
Dimensions	35.5 x 111 x 138 mm, 1.39 x 4.37 x 5.43 inches

Packaging

Shipping Weight	0.52 Kg, 1.15 lbs
Shipping Dimensions	170 x 260 x 70 mm, 6.69 x 10.24 x 2.76 inches
Contents Shipped	Industrial Ethernet Switch with DIN Rail attachment Terminal block Installation guide

Standards and Certifications

Safety	UL 60950-1
--------	------------

CSA C22.2 No. 60950-1
 IEC 60950-1:2005+A1:2009 and
 EN 60950-1:2006+A11:2009+A1:2010+A12:2011
 CE Mark
 UL508 (Industrial)

EMC Emissions FCC 47 Part 15 Class A
 ICES-0003
 CISPR 22:2008/EN55022:2010 (Class A)
 EN61000-6-4

EMC Immunity CISPR 24:2010/EN 55024:2010
 IEC/EN 61000-4-2 (ESD) : Contact discharge +/- 4kV, Air Discharge +/- 8kV
 IEC/EN 61000-4-3 (RS) : 80 MHz to 2.7 Ghz ; 10V/m, 800 MHz to 1000 MHz; 20V/m
 IEC/EN 61000-4-4 (EFT) : DC power line +/- 2 kV, Data Line +/- 1kV
 IEC/EN 61000-4-5 (Surge) : DC power line, Line/Line +/- 0.5kV, Line/Earth +/- 0.5kV, Data Line line/earth +/- 1kV
 IEC/EN 61000-4-6 (CS) : 150kHz to 80 MHz; 10V
 IEC/EN 61000-4-8 : 30A/m
 IEC/EN 61000-6-2 (General Immunity in Industrial Environments)

Industrial Safety UL508 (Safety standard for Industrial Control Equipment)
 CSA C22.2 No. 142

Hazardous Locations (Hazloc) ANSI/ISA 12.12.01, Class I Division 2 Groups A-D (formerly known as UL 1604)
 CSA C22.2 No. 213
 ATEX Class I Zone 2, EN 60079-0,15

Laser Safety EN 60825-1:2007
 Fiber optic transmitters on this device meet Class 1 Laser safety requirements per IEC-60825 FDA/CDRH standards and comply with 21CFR1040.10 and 21CFR1040.11.

Environmental [Reach, RoHS and WEEE Compliant](#)

Other ECCN: 5A991

HTSUS Number: 8517.62.0050

5 year warranty

IDS-105GPP with Standard DIN Rail

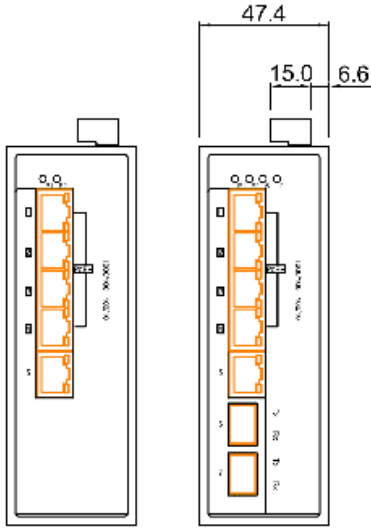
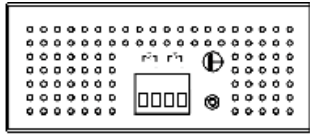

RJ45 Models SFP Models

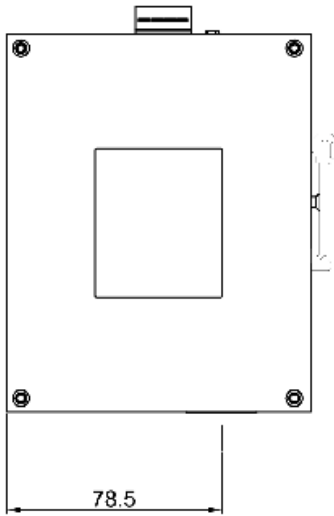
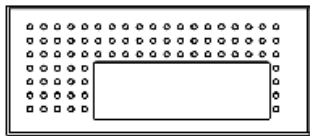
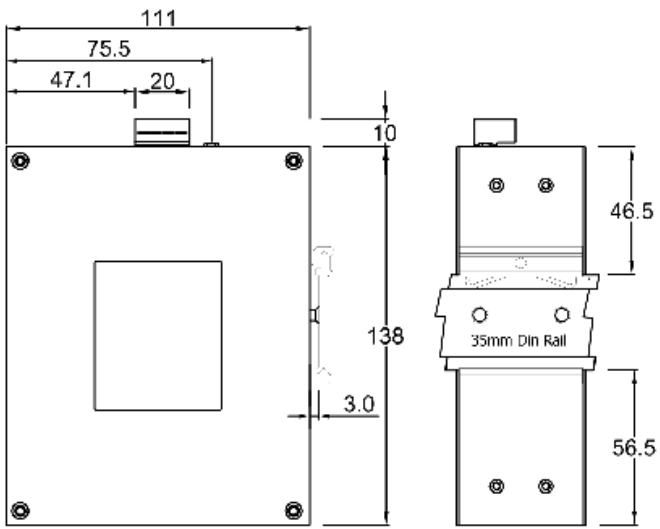

SC Models

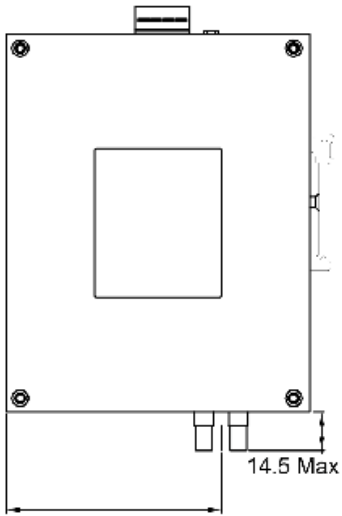

ST Models

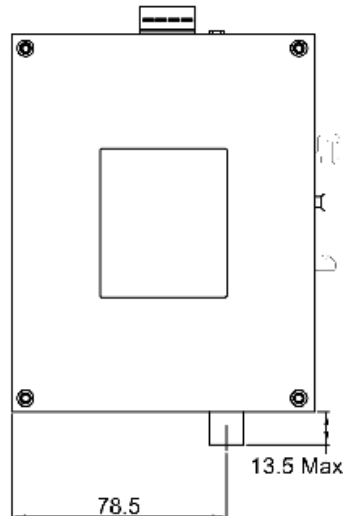

Single Fiber Models

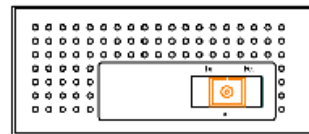
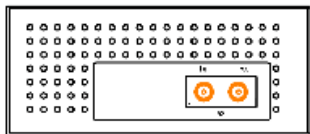
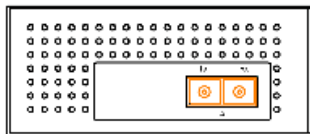

IDS-105GPP with Optional Wall/Panel Mount Brackets

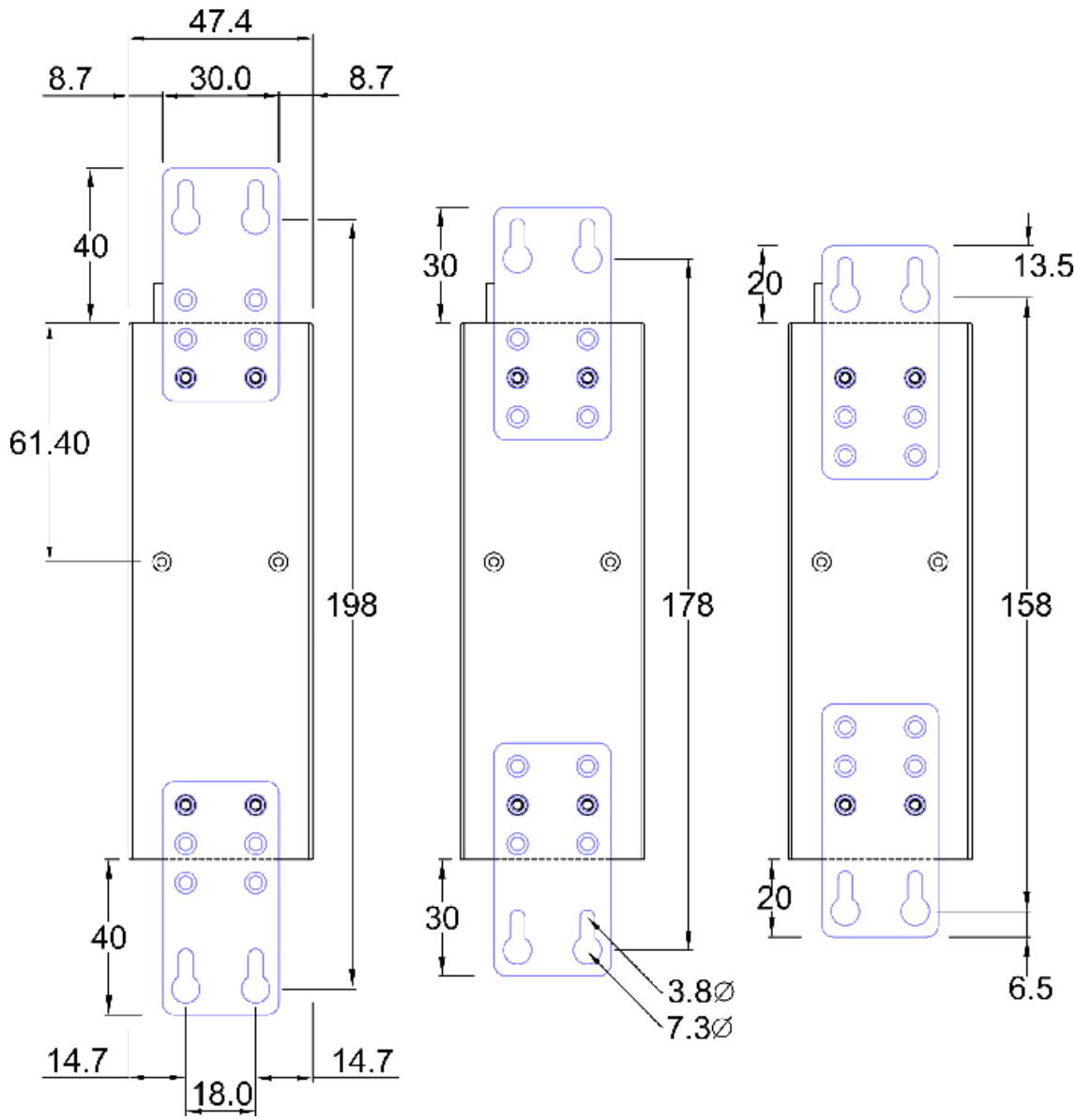

IDS-105GPP Industrial Switch Power over Ethernet (PoE)Diagram

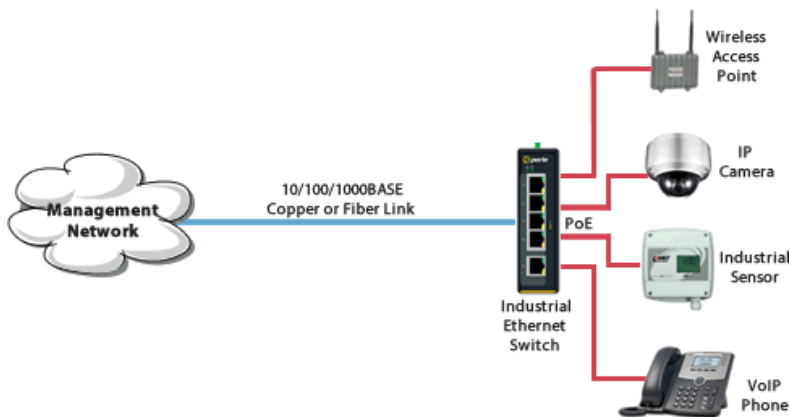

Single Mode / Single Strand (WDM) Fiber

Connecting devices over a single fiber strand (also referred to as “Bi-Directional” BiDi or Simplex)

To reduce costs, or where there are limits on available fiber, Wavelength-Division Multiplexing (WDM) technology may be utilized. WDM uses separate transmit and receive frequencies to communicate on a single fiber strand. WDM technology relies on the fact that optical fibers can carry many wavelengths of light simultaneously without interaction between each wavelength. Thus, a single fiber can carry many separate wavelength signals or channels simultaneously. WDM systems are divided into different wavelength patterns, conventional/coarse (CWDM) and dense (DWDM).

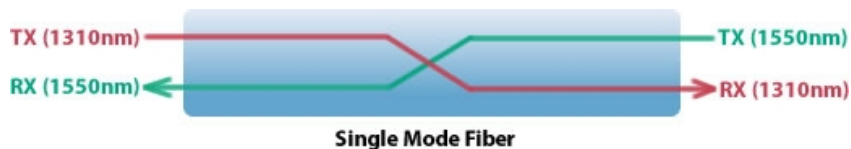

When Single Strand fiber is used, you will need an “Up” side and a “Down” side when interconnecting fiber devices.

Perle offers a wide variety of Single Fiber (“Up/Down”) [Ethernet Switches](#) and [Media Converters](#) for use with single strand of fiber.

Select a Model to obtain a Part Number – IDS-105GPP

Std = Standard Temperature models : 0° C to 60° C (32° F to 140° F).
 Ind = Industrial Extended Temperature Models : -40° C to 75° C (-40 F to 167° F)

Duplex Fiber

Model	Temp	RJ45 10/100/1000Base- T Connectors	Fiber Connector	Transmit (dBm)		Receive (dBm)		Power Budget (dB)	Wavelength (nm)	Fiber Type	Operating Distance
				Min	Max	Min	Max				
IDS-105GPP	Std	5									
IDS-105GPP-XT	Ind	5									
IDS-105GPP-SFP	Std	5	1 x SFP slot (empty)	Fiber specifications are dependent upon the choice of SFP used							
IDS-105GPP-	Ind	5	1 x SFP slot (empty)	Fiber specifications are dependent upon the choice of SFP used							

SFP-XT

IDS-105GPP-DSFP	Std	5	2 x SFP slot (empty)	Fiber specifications are dependent upon the choice of SFP used							
IDS-105GPP-DSFP-XT	Ind	5	2 x SFP slot (empty)	Fiber specifications are dependent upon the choice of SFP used							
IDS-105GPP-M2SC05	Std	5	1 x Duplex SC	-9.5	-4.0	-17.0	-3.0	7.5	850	MMF	550 m (1,804 ft)
IDS-105GPP-M2SC05-XT	Ind	5	1 x Duplex SC	-9.5	-4.0	-17.0	-3.0	7.5	850	MMF	550 m (1,804 ft)
IDS-105GPP-M2ST05	Std	5	1 x Duplex ST	-9.5	-4.0	-17.0	-3.0	7.5	850	MMF	550 m (1,804 ft)
IDS-105GPP-M2ST05-XT	Ind	5	1 x Duplex ST	-9.5	-4.0	-17.0	-3.0	7.5	850	MMF	550 m (1,804 ft)
IDS-105GPP-M2SC2	Std	5	1 x Duplex SC	-6.0	0.0	-17.0	0.0	11.0	1310	MMF	2 km (1.2 mi)
IDS-105GPP-M2ST2	Std	5	1 x Duplex ST	-6.0	0.0	-17.0	0.0	11.0	1310	MMF	2 km (1.2 mi)
IDS-105GPP-S2SC10	Std	5	1 x Duplex SC	-9.5	-3.0	-20.0	-3.0	10.5	1310	SMF	10 km (6.2 mi)
IDS-105GPP-S2SC10-XT	Ind	5	1 x Duplex SC	-9.5	-3.0	-20.0	-3.0	10.5	1310	SMF	10 km (6.2 mi)
IDS-105GPP-S2ST10	Std	5	1 x Duplex ST	-9.5	-3.0	-20.0	-3.0	10.5	1310	SMF	10 km (6.2 mi)
IDS-105GPP-S2ST10-XT	Ind	5	1 x Duplex ST	-9.5	-3.0	-20.0	-3.0	10.5	1310	SMF	10 km (6.2 mi)
IDS-105GPP-S2SC40	Std	5	1 x Duplex SC	-2.0	2.0	-23.0	-3.0	21.0	1310	SMF	40 km (24.9 mi)
IDS-105GPP-S2ST40	Std	5	1 x Duplex ST	-2.0	2.0	-23.0	-3.0	21.0	1310	SMF	40 km (24.9 mi)

IDS-105GPP-S2SC70	Std	5	1 x Duplex SC	-2.0	5.0	-23.0	-3.0	21.0	1550	SMF	70 km (43 mi)
IDS-105GPP-S2ST70	Std	5	1 x Duplex ST	-2.0	5.0	-23.0	-3.0	21.0	1550	SMF	70 km (43 mi)
IDS-105GPP-S2SC120	Std	5	1 x Duplex SC	0.0	5.0	-32.0	-9.0	32.0	1550	SMF	120 km (74.6 mi)
IDS-105GPP-S2ST120	Std	5	1 x Duplex ST	0.0	5.0	-32.0	-9.0	32.0	1550	SMF	120 km (74.6 mi)
IDS-105GPP-S2SC160	Std	5	1 x Duplex SC	2.0	5.0	-34.0	-9.0	36.0	1550	SMF	160 km (100 mi)
IDS-105GPP-S2ST160	Std	5	1 x Duplex ST	2.0	5.0	-34.0	-9.0	36.0	1550	SMF	160 km (100 mi)

* 1db/km multimode 50/125 micron fiber cable

Single Fiber (Simplex / BiDi) Models (Recommended use in pairs)

Simplex (BiDi) Fiber

Model	Temp	RJ45s 10/100Base-TX Connectors	Fiber Connector	Transmit (dBm)		Receive (dBm)		Power Budget (dB)	Wavelength (nm) TX / RX	Fiber Type	Operating Distance
				Min	Max	Min	Max				
IDS-105GPP-S1SC10U	Std	5	1 x Simplex SC	-9.0	-3.0	-20.0	-3.0	11.0	1310 / 1490	SMF	10 km (6.2 mi)
IDS-105GPP-S1SC10D	Std	5	1 x Simplex SC	-9.0	-3.0	-20.0	-3.0	11.0	1490 / 1310	SMF	10 km (6.2 mi)
IDS-105GPP-S1SC10U-XT	Ind	5	1 x Simplex SC	-9.0	-3.0	-20.0	-3.0	11.0	1310 / 1490	SMF	10 km (6.2 mi)
IDS-105GPP-S1SC10D-XT	Ind	5	1 x Simplex SC	-9.0	-3.0	-20.0	-3.0	11.0	1490 / 1310	SMF	10 km (6.2 mi)
IDS-105GPP-S1SC20U	Std	5	1 x Simplex SC	-8.0	-3.0	-22.0	-3.0	14.0	1310 / 1490	SMF	20 km (12.4 mi)
IDS-105GPP-S1SC20D	Ind	5	1 x Simplex SC	-8.0	-3.0	-22.0	-3.0	14.0	1490 / 1310	SMF	20 km (12.4 mi)
IDS-105GPP-S1SC40U	Std	5	1 x Simplex SC	-3.0	2.0	-23.0	-3.0	20.0	1310 / 1490	SMF	40 km (24.9 mi)
IDS-105GPP-S1SC40D	Std	5	1 x Simplex SC	-3.0	2.0	-23.0	-3.0	20.0	1490 / 1310	SMF	40 km (25 mi)

IDS-105GPP-S1SC80U	Std	5	1 x Simplex SC	-2.0	3.0	-26.0	-3.0	24.0	1510 / 1590	SMF	80 km (50 mi)
IDS-105GPP-S1SC80D	Std	5	1 x Simplex SC	-2.0	3.0	-26.0	-3.0	24.0	1590 / 1510	SMF	80 km (50 mi)
IDS-105GPP-S1SC120U	Std	5	1 x Simplex SC	-3.0	2.0	-34.0	-9.0	31.0	1510 / 1590	SMF	120 km (74.6 mi)
IDS-105GPP-S1SC120D	Std	5	1 x Simplex SC	-3.0	2.0	-34.0	-9.0	31.0	1590 / 1510	SMF	120 km (74.6 mi)

Industrial Ethernet Switch Accessories

Panel Mount kit PM3	Brackets for attaching 30 to 40mm wide Perle IDS industrial switches inside a control panel or to a wall.
Rack Mount Kit RM4U	Bracket for mounting one or more Perle DIN Rail switches in a standard 19" rack. Occupies "4U" of vertical rack space. 275 mm (10 inches) deep
DIN Rail 48V Power Supply	IDPS-48-240-XT - DIN-Rail 48 VDC, 240Watt power supply with universal 85 to 264 VAC or 120-370 VDC input , -20 to 70°C extended operating temperature. Power Supply Specifications.