

B928

5MP Outdoor Speed Dome with D/N, Adaptive IR, Extreme WDR, SLLS, 36x Zoom Lens



- 5 Megapixel
- Day & Night with Superior Low Light Sensitivity and Adaptive IR LED
- 36x Zoom Lens with f4.6-165.6mm/F1.55-F5.0, DC iris, Auto focus
- Extreme WDR
- Endless Pan & Tilt
- H.265 Compression
- Taiwan IoT Cybersecurity Certification Level 1 (TAICS)
- Event trigger, response and notification

► Specifications

Device

Product Type	Speed Dome
Maximum Resolution	5MP
Application Environment	Outdoor
Image Sensor	Progressive Scan CMOS
Sensor Size	1/2.9 "
Effective Pixels	3096(H) X 2202(V) (6.82 MP)
Day / Night	Yes
Low Light Sensitivity	Superior
Minimum Illumination	Color: 0.003 lux at F1.55; B/W: 0 lux (IR LED on)
Color to B/W Switch	ISP based switch, configurable
Mechanical IR Cut Filter	Yes
IR Sensitivity Range	700-1100nm
IR LED	Adaptive IR LED x 6 (850 nm)
IR Working Distance	150m
Electronic Shutter	1/5-1/64000 second (manual mode); 1/5-1/64000 second (auto mode)

Horizontal Resolution (TV Lines)	1750 TVL
S/N Ratio	56 dB

Lens

Focal Length	Zoom, f4.6-165.6mm
Aperture	F1.55-F5.0
Zoom Ratio	36x optical zoom
Zoom Speed	2 second (wide to tele)
Zoom Application	Camera Installation, Auto Zoom by Event, Manual Operation
Iris	DC iris
Focus	Learning-based Auto Focus
Lens Mount	Board mount
Horizontal Viewing Angle	51.14° - 2.17°
Vertical Viewing Angle	39.62° - 1.62°

PTZ

Scan Panning / Tilting Speed	1.6° - 64°/second, 1.6° - 32°/second
Manual Panning / Tilting Speed	0.16° - 54.4°/second, 0.16° - 27.2°/second
Preset Panning / Tilting Speed	0.16° - 300°/second, 0.16° - 150°/second
Panning Range	360° endless
Tilting Range	-20°~200°
PTZ Control	Remote manual control, 256 preset points, 10 preset tours, Auto scan
Preset Accuracy (Panning/Tilting)	±0.265°/±0.265°
Absolute Position	Yes
Pan, Tilt or Zoom protocol	Visca, Pelco-D, Pelco-P, ACTi URL command

Video

Compression	H.265, H.264 (Baseline/ Main/ High profile), MJPEG
Maximum Frame Rate vs. Resolution	30 fps at 2592 x 1944 30 fps at 2048 x 1536 30 fps at 1920 x 1080 30 fps at 1280 x 960 30 fps at 1280 x 720 30 fps at 800 x 600 30 fps at 640 x 480 30 fps at 320 x 240
Multi-Streaming	Simultaneous triple streams based on three configurations
Bit Rate	128Kbps - 12Mbps (per stream)
Bit Rate Mode	Constant, Variable
Wide Dynamic Range	Extreme WDR (120 dB)
Image Enhancement	White Balance, Brightness, Contrast, Saturation, Sharpness, Automatic gain control, Flickerless, Defogging
Digital Noise Reduction	2D + 3D DNR
Privacy Mask	32 configurable 3D privacy masks (To be available through future firmware upgrade)
Text Overlay	Yes

Built-in Analytics	Object Based Motion Detection, Tampering Detection, Shock Detection
Server-based Analytics	Object Line Counting, People Counting, Face Detection, Object Based Motion Detection, Tamper, Object Line Crossing Detection, Object Enter Area Detection, Missing Object Detection, Unattended Object Detection, Smoke Detection, Heat Map, Dwell Time, Direction Detection, Automatic License Plate Recognition, People Queue Detection, (Require PC-based or standalone IVS or ALPR Server. Contact ACTi support for recommendations on how to maximize analytical accuracy)
Image Orientation	Flip, Mirror

Audio

Audio Type	2-way, Line-in, Line-out
Audio Compression	8 kHz, 16 bit encoding, Mono, PCM, G.711

Network

Network Protocol & Service	IPv4/v6, TCP, UDP, DHCP, PPPoE, HTTP, HTTPS, DNS, DDNS, NTP, RTP, RTSP, RTCP, SMTP, FTP, IGMP, ICMP, ARP, Bonjour, UPnP, QoS, SNMP, IEEE 802.1X
Ethernet Port	1 x RJ-45 pigtail connector
Security	IP address filtering, HTTPS encryption, Password protected user level, Anonymous login, IEEE 802.1X network access control, Standard IoT Security (anti-hacking, anti-malware)

Event

Event Trigger	Video motion detection (10 included and excluded polygonal regions), External device through digital input, Tampering detection, Shock Detection, Sound detection, Video streams loss, System log buffer overrun, Remove system log, Logon events (Login Failure, Login Success, Block an Account)
Event Response	Notify control center, Go to PTZ preset point or preset tour, Change camera settings, Command other devices, E-mail notification with snapshots, Push notification to mobile device, Save video to local storage, Upload video or snapshot to FTP server, Activate external device through digital output

System

System Log	Support
Watchdog	Support

Integration

Unified Solution	Fully compatible with ACTi software
Software Development Kit	Yes
GPS Position	Manual setting
Edge Recording	Support (integration with NVR by ONVIF Profile G or proprietary protocol)**
ONVIF Compliant	Yes, Profile S, Profile G, Profile T, Profile M* (To be available through future firmware upgrade)
GB28181 Compliant	Yes
Web Browser	IE 11, Google Chrome*, Microsoft Edge*, Apple Safari*
Auto Firmware Upgrade	Yes

Interface

Audio Interface	1/1, Cable with 3.5mm Phone Jack
-----------------	----------------------------------

Local Storage	MicroSDHC, MicroSDXC Memory Card Slot (card not included, up to 256GB, Kingston or Sandisk only)
Digital Input/Output	4/2 (Cable with Terminal block)
Operating Button	Reset Button

General

Power Source	AC 24V, High PoE 75W
Power Consumption	56 W (PoE, heater and fan on), 62 W (AC, heater and fan on)
Weight	3146g (6.936lb)
Dimensions	(Ø x H): Outdoor: 170mm x 260mm (6.69" x 10.24")
Environmental Casing	Weatherproof (IP66), Vandal proof metal casing (IK10), Built-in dehumidifier, Scratch-resistant and water-repellent lens glass
Bundled Accessories	High PoE injector (for USA) or Power Adapter (for other countries)
Mount Type	Wall Mount, Pendant, Corner Mount, Pole Mount, Gang Box
Fan	Yes
Heater	Yes
Dehumidifier	Yes
Starting Temperature	-40°C ~ 55°C (-40°F ~ 131°F) within 30 minutes
Operating Temperature	-40°C ~ 55°C (-40°F ~ 131°F)
Operating Humidity	10% - 85% RH
Approvals	CE Class B, FCC Class B, EAC, IP66, NEMA 4X, IK10 (metal casing), Taiwan IoT Cybersecurity Certification Level 1 (TAICS)
Material	Housing Material: Metal
Real-time Clock (RTC)	Yes
Warranty	3 Year(s) (1 year in continuous motion). For extended warranty offering, see http://www.acti.com/support/warranty

* cross-browser compatibility: Not available for H.265 video decoding and Intelligent Video settings ** Edge Recording function is integrated with NVR 3 Corporate / NVR 3 Business / INR / GNR series.

► Photo Indication



- 1 Power LED
- 2 Reset Button
- 3 Memory Card Slot
- 4 Audio Output
- 5 Audio Input
- 6 Digital Input/Output
- 7 AC 24V Power Input
- 8 Ethernet Port

► Dimension Diagram

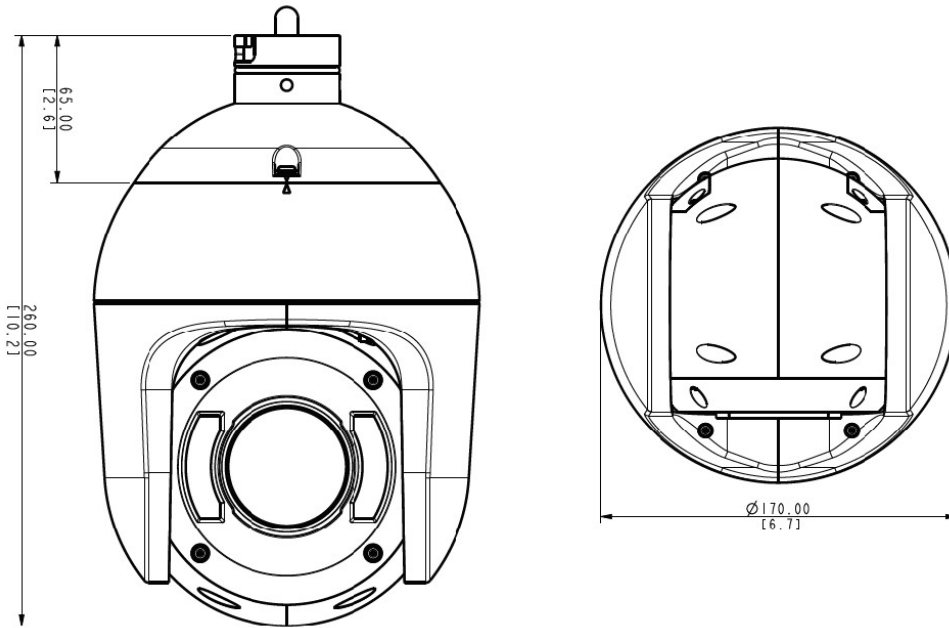













Unit: mm [inch]

Unit: mm [inch]



► Related Products

Mounting Accessories - Camera Mount

PMAX-0102		Straight Tube
PMAX-0103		Straight Tube with Bracket
PMAX-0104		Extension Tube
PMAX-0302		Gooseneck with Bracket
PMAX-0303		Gooseneck
PMAX-0312		PTZ Wall Mount for Outdoor PTZ / Speed Dome (except KCM-8211 & TCM-6630)
PMAX-0402		Corner Mount
PMAX-0503		Pole Mount (for PMAX-0102, PMAX-0312, PMAX-0313, PMAX-0314, PMAX-0702, PMAX-1106, PMAX-1107), supports 5.25" to 8.5" Poles
PMAX-0505		Pole Mount (for B4x, B41x, E44, E45, E46, E48, E44A, E45A, E46A, E41x, I4x, PMAX-0312, PMAX-0313, PMAX-0314, PMAX-0330), supports 2" to 3" Poles
PMAX-0702		Junction Box for PTZ and Dome Cameras
PMAX-0807		Gangbox Converter (for PMAX-0102, PMAX-0312, PMAX-0313, PMAX-0314, PMAX-0321), supports Two-Gang Boxes
PMAX-0808		Converter Ring, 1.5" NPT for Third-Party Mounting Accessories

Note: Some mounting accessories may need additional accessories for installation. Please check www.acti.com/mountingselector for more information.

Power Supply Accessories - PoE Injector

PPOE-0103		High PoE Injector, Single-port, 60W Gigabit Midspan, 4-Pairs, 802.3at Compliant, AC 100~240V, with universal connectors (for, I93~I910, I915, B915~B917, B922, B928, B945, B949, A950, A951)
PPOE-0104		High PoE Injector, Single-port, 10/100/1000Mbps 60W, 4-Pairs, 802.3at Compliant, AC 100~240V, with universal connectors (for, I93~I910, I915, B915~B917, B922, B928, B945, B949, A950, A951)

Network & Storage Peripherals - Data Switch

PPSW-0105		PLANET GS-4210-8P2C 8-Port Gigabit 802.3at Managed PoE Switch (PoE Budget 120W)
-----------	---	---

Extenders - PoE Extender

PPEX-0100



Veracity OUTREACH Max Power over Ethernet (PoE) Extender

Extenders - PoE over Coaxial Extender Kit

PPOC-0100



Planet LRP-101C-KIT Power over Coax Adapter Kit

Audio Devices - Microphone

PMIC-0100



Active Microphone Omnidirectional for all Cameras with Line-in Audio

Illuminators - IR LED Illuminator

PLED-0200



SPINLUX (SL-A2IRXX10-24CL) IR Illuminator 10° Angle with 120 m approx. range

PLED-0201



SPINLUX (SL-A2IRXX25-24CL) IR Illuminator 25° Angle with 50 m approx. range