

# E76

## 2MP Outdoor Dome with D/N, Adaptive IR, Basic WDR, SLLS, Fixed Lens



- 2 Megapixel with 1080p
- Day & Night with Superior Low Light Sensitivity and Adaptive IR LED
- Wide Angle Fixed Lens with f3.6mm / F1.85
- Basic WDR (75 dB)
- 30 fps at 1920 x 1080
- Weatherproof (IP67) and Vandal Proof (IK10)

### PHOTO INDICATION

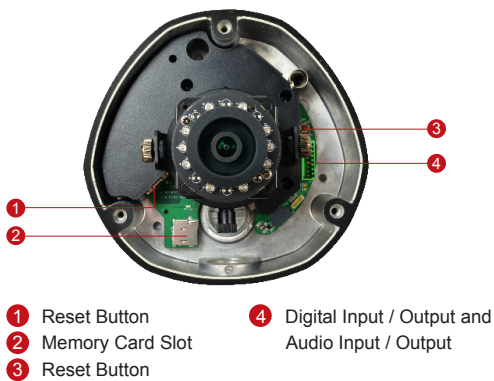



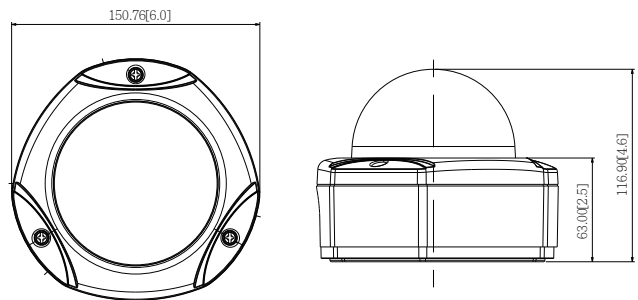

### DIMENSION DIAGRAM

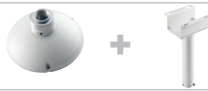

Unit: mm [inch]

### ACCESSORY OPTIONS

Dome Cover		
PDCX-1109		Smoked dome cover for B6X/B8X/B9X, vandal proof (IK10)
Power Supply		
PPOE-0001		IEEE 802.3af PoE Injector for Class 1, 2 or 3 devices, with universal adapter

Popular Mounting Solutions		
Surface	Accessories not required	
Wall	PMAX-0314	
Pendant	PMAX-0101 PMAX-0103	
Corner	PMAX-0314 PMAX-0402	
Pole	PMAX-0314 PMAX-0503	
Flush	PMAX-1013	
Gang Box	PMAX-0804	

\* For more mounting solutions, please refer to Project Planner on [www.acti.com](http://www.acti.com)

## PRODUCT SPECIFICATION

### E76

#### • Device

Device Type	Outdoor Dome Camera
Image Sensor	Progressive Scan CMOS
Sensor Size	1/2.8"
Effective Pixels	1984(H) X 1225(V) (2.43 MP)
Horizontal Resolution	1100 TVL
Day / Night	Yes
Low Light Sensitivity	Superior
Minimum Illumination	Color: 0.1 lux at F1.85 (30 IRE, 2400°K); B/W: 0 lux (IR LED on)
Color to B/W Switch	ISP based switch, configurable
Mechanical IR Cut Filter	Yes
IR Sensitivity Range	700~1100nm
IR LED	Adaptive IR LED x 10 (850nm)
IR Working Distance	30 m (0 lux, 30 IRE, Gain 255, Auto shutter mode)
Electronic Shutter	1/5 ~ 1/2,000 sec (manual mode); 1/5 ~ 1/10,000 sec (auto mode)
S/N Ratio	52 dB

#### • Lens

Focal Length / Aperture	Fixed focal, f3.6 mm / F1.85
Iris	Fixed iris
Focus	Fixed focus
Mount Type	Board mount
Horizontal Viewing Angle	87.5°
Viewing Angle Adjustment	Pan: 0°~350°; Tilt: 17°~163°; Rotate: 0°~350°

#### • Video

Compression	H.264 (Baseline/ Main/ High profile), MJPEG
Max. Frame Rate vs. Resolution	30 fps at 1920 x 1080; 30 fps at 1280 x 960; 60 fps at 1280 x 720; 30 fps at 800 x 600; 30 fps at 640 x 480; 15 fps at 320 x 240; 15 fps at 320 x 240
Multi-Streaming	Simultaneous dual streams based on two configurations
Bit Rate	28 Kbps - 6 Mbps (per stream)
Bit Rate Mode	Constant, Variable
Image Enhancement	Basic WDR (75 dB); White balance: automatic, hold, and manual; Brightness; Contrast; Sharpness (auto); Auto gain control; Digital noise reduction; Flickerless
Privacy Mask	4 configurable regions
Text Overlay	User defined text on video
Image Orientation	Image flip and mirror

#### • Audio

Compression	8kHz, Mono, PCM, 16 bit encoding, G.711
Audio-In	Terminal block
Audio-Out	Terminal block

#### • Network

Protocol & Service	TCP, UDP, HTTP, HTTPS, DHCP, PPPoE, RTP, RTSP, IPv4, IPv6, DNS, DDNS, NTP, ICMP, ARP, IGMP, SMTP, FTP, UPnP, SNMP, Bonjour
Ethernet Port	1, Ethernet (10/100 Base-T), RJ-45 connector
Security	IP address filtering; HTTPS encryption; Password protected user levels; Anonymous login; IEEE 802.1X network access control

#### • Alarm

Alarm Trigger	Video motion detection (3 regions); External device through digital input; Sound detection
Alarm Response	Notify control center; Change camera settings; Command other devices; E-mail notification with snapshots; Save video or snapshot to local storage; Upload video, snapshot to FTP Server; Active external device through digital output

#### • Interface

Digital Input	1, Terminal block
Digital Output	1, Terminal block
Local Storage	MicroSDHC/MicroSDXC memory card slot (card not included)

#### • General

Power Source / Consumption	PoE Class 2 (IEEE802.3af) / 6.49W (IR on)
Weight	1.001 kg (2.207 lb)
Dimensions (Ø x H)	150.4 mm x 116.9 mm ( 5.9" x 4.6")
Environmental Casing	Weatherproof (IP67 rated); Vandal proof (IK10 rated); Transparent dome cover
Mount Type	Surface, Pendant, Wall, Corner, Pole, Flush, Gang box
Starting Temperature	-20°C ~ 50°C (-4°F ~ 122°F)
Operating Temperature	-40°C ~ 50°C (-40°F ~ 122°F)
Operating Humidity	10% ~ 85% RH
Approvals	CE (EN 55022 Class B, EN 55024), FCC (Part15 Subpart B Class B), IK10, IP67, NEMA 4X, UL (for optional PoE injector)

#### • Integration

Unified Solution	Fully compatible with ACTi software
ISV Integration	Software Development Kit (SDK) available; ONVIF compliant
Firmware Access Browser	Microsoft Internet Explorer 8.0 or newer (full functionality) Safari with QuickTime installed, and other browsers with VLC installed (partial functionality)
Auto Firmware Upgrade	Yes
GPS Position	Manual Setting

\* All specifications are subject to change without notice.

\* All brand names and registered trademarks are the property of their respective owners.

[www.acti.com](http://www.acti.com)

