

Products (/products/) > Connectivity (/products/network-connectivity/) > Fiber Telecom (T1/E1/PRI, Analog and ISDN) (/products/network-connectivity/#28) > Fiber Isolators for Nortel Meridian Systems (/products/network-connectivity/#28) > FiberPlex FOI-3900

[View Printable \(/products/product_detail.asp?id=562&v=print\)](/products/product_detail.asp?id=562&v=print)

Fiber Isolators for Nortel Meridian Systems

FiberPlex FOI-3900 Fiber Optic Isolator/Converter/Modem - Nortel Meridian telephone circuits; mission critical packaging



FiberPlex

Packed in rugged military style metal enclosures, the FOI-3900 Series interconnects Nortel Phones and PBXs over Fiber for Isolation and Extension

Overview

The FOI-3901 and FOI-3902 both provide complete electrical isolation for Nortel's Meridian™ M2000 and M3000 series digital telephones. The FOI-3901 connects to the digital line card and automatically senses and corrects any improper polarity reversals on the RJ-11. The bidirectional signaling between the digital line card and telephone is then carried across a duplex fiber cable.

The FOM-3902 reproduces the digital signaling at the isolated end of the fiber optic link and provides power ($\pm 15\text{VDC}$ @ 50mA) sufficient to operate M2000 and M3000 series digital telephones. The FOI-3902 is compatible with Nortel's A0367335 plug-in transformer, which provides power to support the additional features on the M2016S digital telephone. A closet power

Features

- Provides fiber connectivity for Nortel Meridian Phone Systems
- Supports all system features on Nortel's Meridian™ M2000 and M3000 series digital telephones
- Supports balanced 2-wire signaling between PBX and digital telephone
- Rugged metal enclosures with RFI shielding

supply can also be used to provide auxiliary power.

The user can achieve complete electrical isolation for Nortel's Meridian™ M2000 and M3000 series digital telephones in areas of high electrical noise or in/out of RF shielded enclosures (SCIF). The fiber optic cable is not susceptible to induced impulse noise and since signal ground is not carried over the link, the signal is not affected by elevated ground potential from lightning or other sources. The fiber optic cable enhances privacy of communications. Fiber optic cable offers much longer transmission distance than traditional wiring. Nortel's Meridian™ digital telephones are limited to a distance of 1750 feet (458m) from the PBX to the telephone, but optics on the module extend the distance to 2km.

FOI version units can be mounted in several redundant powering chassis; rack and wall mount options including Tempest and NEMA alternatives.

Applications

A typical link consists of an FOI-3901 at the PBX and an FOI-3902 at the telephone with a duplex fiber optic cable in between.

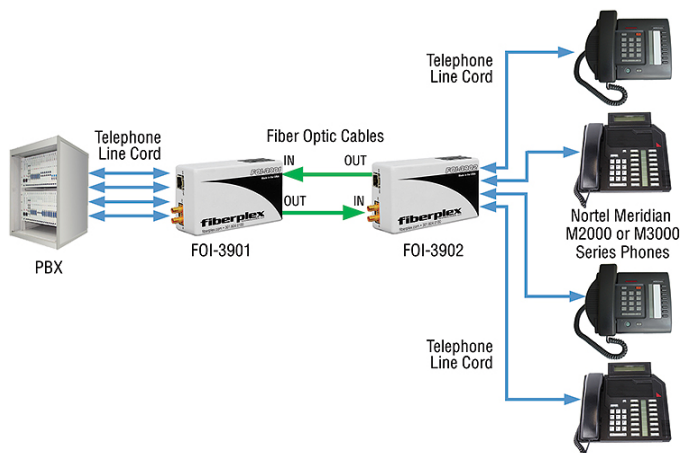

Specifications

The specifications for this product are contained in the User Manual

Ordering

# Model #	Description	Availability
1 FOI-3902-ST	Isolator for Nortel Meridian M2000 and M3000 series telephones, Phone side, Multimode ST optics, Power Options Sold Separately	Pre-Order Available
+ Accessories		

Item Number	Item Description	Price
SVC-SmartCare-BH (/support/support.asp)	Premium Support for Business Hours	Contact us (/howtobuy/) for availability and pricing.
SVC-SmartCare-24/7 (/support/support.asp)	Premium Support, 24 x 7 Coverage	Contact us (/howtobuy/) for availability and pricing.
SVC-SmartAssist-BH (/support/support-professional.asp)	Business Hour Support Services	Contact us (/howtobuy/) for availability and pricing.
SVC-SmartAssist-AH (/support/support-professional.asp)	After Hours Support Services	Contact us (/howtobuy/) for availability and pricing.
SVC-ENHWAR1 (/support/support-warranty.asp)	1 Year Enhanced Warranty	Contact us (/howtobuy/) for availability and pricing.
SVC-ENHWAR2 (/support/support-warranty.asp)	2 Year Enhanced Warranty	Contact us (/howtobuy/) for availability and pricing.

SVC-ENHWAR3 (/support/support-warranty.asp)	3 Year Enhanced Warranty	Contact us (/howtobuy/) for availability and pricing. Contact us (/howtobuy/) for availability and pricing. Contact us (/howtobuy/) for availability and pricing.
SVC-ENHWAR4 (/support/support-warranty.asp)	4 Year Enhanced Warranty	Contact us (/howtobuy/) for availability and pricing. Contact us (/howtobuy/) for availability and pricing. Contact us (/howtobuy/) for availability and pricing.
SVC-ENHWAR5 (/support/support-warranty.asp)	5 Year Enhanced Warranty	Contact us (/howtobuy/) for availability and pricing. Contact us (/howtobuy/) for availability and pricing. Contact us (/howtobuy/) for availability and pricing.
SVC-EXTWAR2 (/support/support-warranty.asp)	2 Year Extended Warranty	Contact us (/howtobuy/) for availability and pricing. Contact us (/howtobuy/) for availability and pricing. Contact us (/howtobuy/) for availability and pricing.
SVC-EXTWAR3 (/support/support-warranty.asp)	3 Year Extended Warranty	Contact us (/howtobuy/) for availability and pricing. Contact us (/howtobuy/) for availability and pricing. Contact us (/howtobuy/) for availability and pricing.
SVC-EXTWAR4 (/support/support-warranty.asp)	4 Year Extended Warranty	Contact us (/howtobuy/) for availability and pricing. Contact us (/howtobuy/) for availability and pricing. Contact us (/howtobuy/) for availability and pricing.
SVC-EXTWAR5 (/support/support-warranty.asp)	5 Year Extended Warranty	Contact us (/howtobuy/) for availability and pricing. Contact us (/howtobuy/) for availability and pricing. Contact us (/howtobuy/) for availability and pricing.
SVC-NETENG-HOUR (/support/support-professional.asp)	Network technician hour rate for pre-config services, after hours support, etc.	Contact us (/howtobuy/) for availability and pricing. Contact us (/howtobuy/) for availability and pricing. Contact us (/howtobuy/) for availability and pricing.

Backgrounders

FiberPlex Capabilities Guide

(/backgrounders/FiberPlex_Capabilities_Statement.pdf)

October 6, 2017

Data Sheets

FiberPlex PSQ X909 (/datasheet/Fiberplex_PSQ-X909_150724.pdf)

July 24, 2015

Patton Product Life Cycle Color Codes (/datasheet/Life-Cycle-Availability-Codes.pdf)	April 24, 2015
FiberPlex CMA 2001/3002 (/datasheet/Fiberplex_CMA-2001-3002_150408.pdf)	April 8, 2015
FiberPlex PSQ X910 (/datasheet/Fiberplex_PSQ-x910_130601.pdf)	June 1, 2013
FiberPlex PSQ X920 (/datasheet/Fiberplex_PSQ-x920_130601.pdf)	June 1, 2013
FiberPlex FOI 3901/3902 (/datasheet/Fiberplex_FOI-3901-3902_120101.pdf)	January 1, 2012
FiberPlex RMC 2101 (/datasheet/Fiberplex_RMC-2101_120101.pdf)	January 1, 2012
FiberPlex RMC 3101 (/datasheet/Fiberplex_RMC-3101_120101.pdf)	January 1, 2012
FiberPlex RMC 5000 (/datasheet/Fiberplex_RMC-5000_120101.pdf)	January 1, 2012

Product & Solution Guides

FiberPlex Connectivity Product Guide (/guides/07FPC-OV_lo-res.pdf)	August 24, 2018
Enterprise Networking Products Guide (/guides/07MENTNET-PG-lo.pdf)	November 10, 2010

User Manuals & Configuration Guides

FiberPlex Stand Alone Power Supply PSQ-4912-K User Manual (/manuals/PSQ-4912_User_Manual_170113.pdf)	January 13, 2017
FiberPlex Stand Alone Power Supply PSQ-2909/PSQ-3909/PSQ-4909 PSQ-2920/PSQ-3920/PSQ-4920 User Manual (/manuals/PSQ-X909_X920_User_Manual_150724.pdf)	July 24, 2015
FiberPlex Chassis Mount Adapter CMA-2001/CMA-3002 User Manual (/manuals/CMA_User_Manual_150717.pdf)	July 17, 2015
FiberPlex Rack Mount Chassis RMC/2101/RMC-3101/RMC-3102 User Manual (/manuals/RMC-3101_2101_Manual_150303.pdf)	March 5, 2015

Company (/company/)

- > Contact Us (/company/contact-us.asp)
- > About Patton (/company/about.asp)
- > Jobs (/company/careers/)
- > Capabilities (/products/special/services.asp)
- > Quality & Responsibility (/company/environment/)
- > Legal (/legal/)
- News & Events
- > Press Room/Releases (/press/)
- > Training & Events (/training/)
- > Library/Downloads (/resources/)

Products

(/products/)

Unified Communications

- > VoIP Gateways (/voip-gateway/#products)
- > VoIP Routers (/voip-router/#products)
- > VoIP IADs (/voip-iad/#products)
- > SIP eSBCs (/session-border-controller/#products)
- > VoIP Appliances (/ip-pbx/#products)
- > SS7 Media Gateways (/ss7-

Connectivity

- > Line Drivers / Short Range Modems (/products/network-connectivity/#11)
- > Fiber Serial DataCom (RS-232/422/530/188C) (/products/network-connectivity/#27)
- > Ethernet Over Fiber (/products/network-connectivity/#23)
- > Multiplexers &

Partners & Resources (/partners/)

- > Partner Programs (/partners/)
- > Resources (/resources/)
- > Blog (<https://blog.patton.com>)

[gateway/#products](#)

Software and Cloud

- > Virtual SBC (/virtual-sbc/#products)
- > Virtual Access Router (/virtual-access-router/#products)
- > VPN Server (/vpn-server/#products)
- > IPv6 to IPv4 Network Gateway (/network-gateway/#products)
- > Intelligent Edge Orchestration (/intelligent-edge-orchestration/#products)
- > NFV & SDN (/nfv/#products)

Network Access

- > Ethernet Extenders (/ethernet-extender/#products)
- > PoE Products (/poe/#products)
- > xDSL Products (/xdsl/#products)
- > Routers (/router/#products)
- > Dial-Up Access (/dial-up/#products)

Industrial

- > Industrial Ethernet
- > Unmanaged Industrial Ethernet Switch
- > Managed Industrial Ethernet Switch
- > PoE Industrial Switch

Sunset Products

(/products/sunset-products.asp).

- Sharing Devices (/products/network-connectivity/#12)
- > Fiber Telecom (T1/E1/PRI, Analog and ISDN) (/products/network-connectivity/#28)
- > Pro AV Live and Media Broadcast Fiber Systems (/products/network-connectivity/#29)
- > SFP (Small Form Pluggable) Modules and Kits (/products/network-connectivity/#30)
- > Fiber Alarming, Notification, Relay and Control (/products/network-connectivity/#24)
- > Other Network Extenders (/products/network-connectivity/#13)
- > Defense/Security Fiber Communications (/products/network-connectivity/#22)
- > Baluns (/products/network-connectivity/#3)
- > Surge Protectors & Opto-Isolators (/products/network-connectivity/#15)
- > DataTaps, Testers, Adapters, Rack Kits (/products/network-connectivity/#1)

- connectivity/#7)
- > Interface
- Converters
- (/products/network-connectivity/#10)
- > Fiber Rack and Enclosure Systems
- (/products/network-connectivity/#25)
- > Fiber Repeaters and Wavelength Division Multiplexers (WDM)
- (/products/network-connectivity/#26)
- > Waveguide RF Filters
- (/products/network-connectivity/#31)

Support & Services (/support/)

- > Support Home (/support/)
- > Support Portal (/support/#portal)
- > Premium Support
- (/support/support.asp)
- > Software Upgrades
- (/support/upgrades/)
- > Warranty Services (/support/support-warranty.asp)
- > Returns & RMAs (/returns/)
- > Manuals (/manuals/)

Special Projects Group (SPG) (/products/special)

- > SPG Home (/products/special/)
- > Services & Capabilities
- (/products/special/services.asp)
- > Projects
- (/products/special/projects.asp)
- > Facilities
- (/products/special/facilities.asp)

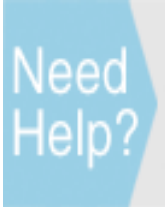

Select your country

Sales: sales@patton.com
(mailto:sales@patton.com) / +1 301 975 1000
Support: support@patton.com
(mailto:support@patton.com) / +1 301 975 1007

Join Our Email List

Have Us Contact You

or

Connect With Us



(<https://twitter.com/pattonconnect>)







(<https://www.linkedin.com/companies/patton-electronics>)



(<https://www.facebook.com/PattonElectronics>)

Copyright © 2001–2020 Patton Electronics Co., All Rights Reserved.

| [Sitemap \(/company/sitemap.asp\)](/company/sitemap.asp) | [Legal \(/legal/\)](/legal/) | [Privacy Policy \(/legal/privacy.asp\)](/legal/privacy.asp) | [Disclaimer \(/legal/terms-conditions.asp\)](/legal/terms-conditions.asp) |  (<https://twitter.com/pattonconnect>) |  (<https://www.facebook.com/PattonElectronics>) |  (<https://www.youtube.com/user/pattonelectronicSCO>) |  (<https://www.linkedin.com/companies/patton-electronics>) |  (</news.rss>)