

# Q113

## 2MP with Basic WDR, SLLS, Fixed Lens



- 2 Megapixel
- Fixed Lens with f3.7mm/F2.5
- Basic WDR
- Wide Angle
- Easy-to-Install for mounting solutions
- Event trigger, response and notification

## ► Specifications

### Device

|                                  |  |
|----------------------------------|--|
| Product Type                     | L-Shape Pinhole Covert   |
| Maximum Resolution               | 2MP  |
| Application Environment          | Indoor   |
| Image Sensor                     | Progressive Scan CMOS  |
| Sensor Size                      | 1/2.8 "  |
| Effective Pixels                 | 1944(H) X 1224(V) (2.38 MP)                                      |
| Day / Night                      | No   |
| Low Light Sensitivity            | Superior   |
| Minimum Illumination             | Color: 0.1 lux at F2.5 (30 IRE, 2400 K)                          |
| Mechanical IR Cut Filter         | No   |
| IR LED                           | No   |
| Electronic Shutter               | 1/5-1/32000 second (manual mode); 1/5-1/32000 second (auto mode) |
| Horizontal Resolution (TV Lines) | 1100 TVL   |
| S/N Ratio                        | 52 dB  |

### Lens

|              |                     |
|--------------|---------------------|
| Focal Length | Fixed focal, f3.7mm |
|--------------|---------------------|

|                          |   |
|--------------------------|---|
| Aperture                 | F2.5                                    |
| Iris                     | Fixed iris                              |
| Focus                    | Fixed focus                             |
| Lens Mount               | RJ12 connector up to 12m from main unit |
| Lens Extension Cable     | 12m cable; RJ-12 connector              |
| Horizontal Viewing Angle | 84.5°                                   |
| Vertical Viewing Angle   | 46.5°                                   |

## Video

|                                   |   |
|-----------------------------------|---|
| Compression                       | H.264 (Baseline/ Main/ High profile), MJPEG   |
| Maximum Frame Rate vs. Resolution | 30 fps at 1920 x 1080 30 fps at 1280 x 720 30 fps at 800 x 600 30 fps at 640 x 480 15 fps at 320 x 240  |
| Multi-Streaming                   | Simultaneous dual streams based on two configurations   |
| Bit Rate                          | 28Kbps - 6Mbps (per stream)   |
| Bit Rate Mode                     | Constant, Variable  |
| Wide Dynamic Range                | Basic WDR (75 dB)   |
| Digital Noise Reduction           | 2D + 3D DNR   |
| Privacy Mask                      | 4 configurable regions  |
| Text Overlay                      | Yes   |
| On-Screen Graphics                | Yes   |
| Server-based Analytics            | Object Line Counting, People Counting, Face Detection, Object Based Motion Detection, Tamper, Object Line Crossing Detection, Object Enter Area Detection, Missing Object Detection, Unattended Object Detection, Smoke Detection, Heat Map, Dwell Time, People Queue Detection, (Require PC-based or standalone IVS or ALPR Server. Contact ACTi support for recommendations on how to maximize analytical accuracy) |

## Audio

|                   |  |
|-------------------|--|
| Audio Type        | 2-way, Mic-in, Line-in, Line-out         |
| Audio Compression | 8 kHz, 16 bit encoding, Mono, PCM, G.711 |

## Network

|                            |   |
|----------------------------|---|
| Network Protocol & Service | IPv4/v6, TCP, UDP, DHCP, PPPoE, HTTP, HTTPS, DNS, DDNS, NTP, RTP, RTSP, RTCP, SMTP, FTP, IGMP, ICMP, ARP, Bonjour, UPnP, QoS, SNMP, IEEE 802.1X |
| Ethernet Port              | 1 x RJ-45 connector   |
| Security                   | IP address filtering, HTTPS encryption, Password protected user level, Anonymous login, IEEE 802.1X network access control                      |

## Event

|                |   |
|----------------|---|
| Event Trigger  | Video motion detection (3 regions), External device through digital input, Sound detection,   |
| Event Response | Notify control center, Change camera settings, Command other devices, E-mail notification with snapshots, Play the audio file, Push notification to mobile device, Save video to local storage, Upload video or snapshot to FTP server, Upload video to NVR server, Activate external device through digital output |

## Integration

|                  |                                     |
|------------------|-------------------------------------|
| Unified Solution | Fully compatible with ACTi software |
|------------------|-------------------------------------|

|                       |                           |
|-----------------------|---------------------------|
| GPS Position          | Manual setting            |
| ONVIF Compliant       | Yes, Profile S, Profile G |
| GB28181 Compliant     | Yes                       |
| Web Browser           | IE 11                     |
| Auto Firmware Upgrade | Yes                       |

## Interface

|                      |   |
|----------------------|---|
| Serial Port          | 1 x RS-232  |
| Audio Interface      | Terminal block  |
| Local Storage        | MicroSDHC, MicroSDXC memory card slot (card not included) |
| Digital Input/Output | 1/1   |

## General

|                       |  |
|-----------------------|--|
| Power Source          | DC 12V, PoE Class 2 (IEEE802.3af)  |
| Power Consumption     | 4.32 W (PoE)   |
| Weight                | 508g (1.120lb)   |
| Dimensions            | Main Unit (W x H x D): 75mm x 100.33mm x 30mm (3.0" x 4.0" x 1.2") Lens Unit (W x H x D): 22mm x 32mm x 21.22mm (0.9" x 1.3" x 0.8") |
| Environmental Casing  | Vibration proof (EN50155)  |
| Mount Type            | Surface, Tilttable Surface Mount, Flush, Tilted Mount, Height Strip, Bracket   |
| Starting Temperature  | -20°C ~ 50°C (-4°F ~ 122°F)  |
| Operating Temperature | -30°C ~ 60°C (-22°F ~ 140°F)   |
| Operating Humidity    | 10% - 85% RH   |
| Approvals             | CE, FCC, EN50155, UL (for optional PoE injector and power adapter)   |
| Warranty              | 3 Year(s)  |

## ▶ Photo Indication



- 1 LED Indicators
- 2 Memory Card Slot
- 3 Digital Input/Output
- 4 Camera Input
- 5 Audio-In/Audio-Out
- 6 Ethernet Port
- 7 Serial Port
- 8 DC 12V Power Input
- 9 Reset Button



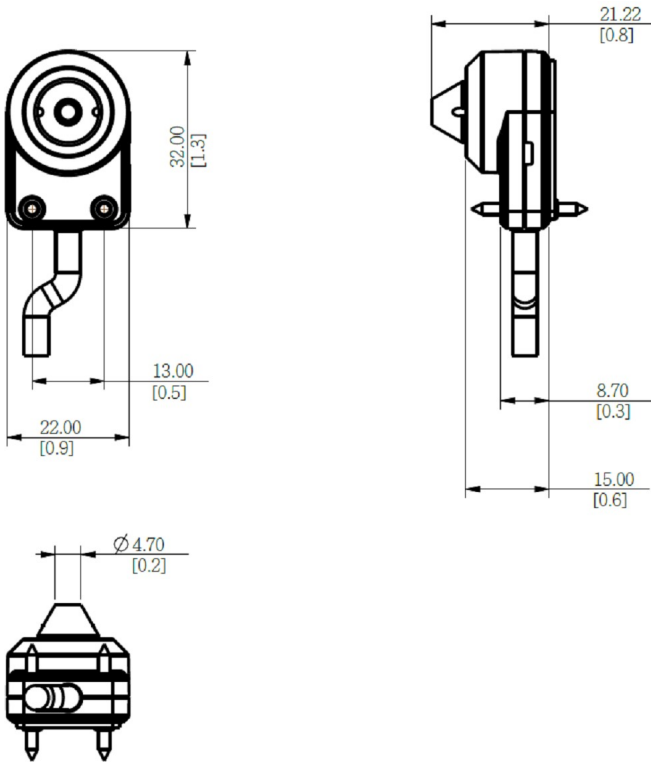







## ▶ Dimension Diagram



Unit: mm [inch]

## ▶ Related Products

### Mounting Accessories - Camera Mount





|            |   |  |
|------------|---|--|
| PMAX-0331  |    | Height Strip Mount (Silver) for L-Shape Pinhole Covert Cameras |
| PMAX-0332  |    | Height Strip Mount (Bronze) for L-Shape Pinhole Covert Cameras |
| PMAX-0334  |    | Tiltable Surface Mount for L-Shape Pinhole Covert Cameras      |
| PMAX-0335  |    | Tilt Wedge (Silver) for PMAX-0331                              |
| PMAX-0336  |    | Tilt Wedge (Bronze) for PMAX-0332                              |
| PMAX-1029  |    | Pinhole Covert Camera Flush Mount                              |
| PMAX-1109  |    | Windshield Mounting Bracket for L-Shape Pinhole Covert Cameras |
| R707-A0004 |   | Bundled Surface Mount for L-Shape Pinhole Covert Camera        |
| R707-A0005 |  | Bundled Tilted Mount for L-Shape Pinhole Covert Camera         |
| R707-A0006 |  | Bundled Flush Mount for L-Shape Pinhole Covert Camera          |
| R707-A0007 |  | Bundled Mounting Rail Kit for Covert Camera                    |

**Note:** Some mounting accessories may need additional accessories for installation. Please check [www.acti.com/mountingselector](http://www.acti.com/mountingselector) for more information.

### Power Supply Accessories - Power Adapter

|           |   |  |
|-----------|---|--|
| PPBX-0011 |  | Power Adapter AC 100~240V, with universal connectors for all DC12V powered devices |
|-----------|---|--|

### Network & Storage Peripherals - Data Switch

|           |   |  |
|-----------|---|--|
| PPSW-0101 |  | PLANET GS-4210-8P2T2S 8-Port Gigabit 802.3at Managed PoE Switch (PoE Budget 240W)  |
| PPSW-0102 |  | PLANET FGSD-1011HP 8-Port 802.3at PoE Switch (PoE Budget 120W)                     |
| PPSW-1101 |  | PLANET GS-4210-24PL4C 24-Port Gigabit 802.3at Managed PoE Switch (PoE Budget 440W) |
| PPSW-3100 |  | PLANET FGSW-1816HPS 16-Port 802.3at PoE Switch (PoE Budget 220W)                   |

### Extenders - PoE Extender

PPEX-0100  Veracity OUTREACH Max Power over Ethernet (PoE) Extender

### Extenders - PoE over Coaxial Extender Kit

PPOC-0100  Planet LRP-101C-KIT Power over Coax Adapter Kit

### Audio Devices - Microphone

PMIC-0100  Active Microphone Omnidirectional for all Cameras with Line-in Audio

PMIC-0201  Passive Microphone Omnidirectional for all Cameras with Mic-In Audio using Cable Wire or Terminal Connector, 2m cable

### Installation Support - Camera Installation Kit

PMON-1001-010  Camera Installation Kit for use with iOS Device with belt bag, battery and charger (US, AC 110~240V)

PMON-1001-011  Camera Installation Kit for use with iOS Device with belt bag, battery and charger (Europe, AC 110~240V)

PMON-2000  Camera Installation Kit