

Q19

5MP with Basic WDR, Fixed Lens



- 5 Megapixel
- Fixed Lens with f2.93mm/F2.0
- Basic WDR
- Wide Angle
- Easy-to-Install for mounting solutions
- Event trigger, response and notification

► Specifications

Device

Product Type	Covert
Maximum Resolution	5MP
Application Environment	Indoor
Image Sensor	Progressive Scan CMOS
Sensor Size	1/3.2 "
Effective Pixels	2592(H) X 1944(V) (5.04 MP)
Day / Night	No
Low Light Sensitivity	Standard
Minimum Illumination	Color: 0.1 lux at F2.0 (30 IRE, 2400 K)
Mechanical IR Cut Filter	No
IR LED	No
Horizontal Resolution (TV Lines)	1350 TVL
S/N Ratio	52 dB

Lens

Focal Length	Fixed focal, f2.93mm
Aperture	F2.0

Iris	Fixed iris
Focus	Fixed focus
Lens Mount	RJ12 connector up to 12m from main unit
Horizontal Viewing Angle	82.3°
Vertical Viewing Angle	62.3°

Video

Compression	H.264 (Baseline/ Main/ High profile), MJPEG
Maximum Frame Rate vs. Resolution	15 fps at 2592 x 1944 15 fps at 2048 x 1536 30 fps at 1920 x 1080 30 fps at 1280 x 720 30 fps at 800 x 600 30 fps at 640 x 480 15 fps at 320 x 240
Multi-Streaming	Simultaneous dual streams based on two configurations
Bit Rate	28Kbps - 6Mbps (per stream)
Bit Rate Mode	Constant, Variable
Wide Dynamic Range	Basic WDR (74 dB)
Digital Noise Reduction	DNR
Privacy Mask	4 configurable regions
On-Screen Graphics	Yes
Server-based Analytics	Object Line Counting, People Counting, Face Detection, Object Based Motion Detection, Tamper, Object Line Crossing Detection, Object Enter Area Detection, Missing Object Detection, Unattended Object Detection, Smoke Detection, Heat Map, Dwell Time, People Queue Detection, (Require PC-based or standalone IVS or ALPR Server. Contact ACTi support for recommendations on how to maximize analytical accuracy)

Audio

Audio Type	2-way, Mic-in, Line-in, Line-out
Audio Compression	8 kHz, 16 bit encoding, Mono, PCM, G.711

Network

Network Protocol & Service	IPv4/v6, TCP, UDP, DHCP, PPPoE, HTTP, HTTPS, DNS, DDNS, NTP, RTP, RTSP, RTCP, SMTP, FTP, IGMP, ICMP, ARP, Bonjour, UPnP, QoS, SNMP, IEEE 802.1X
Ethernet Port	1 x RJ-45 connector
Security	IP address filtering, HTTPS encryption, Password protected user level, Anonymous login, IEEE 802.1X network access control

Event

Event Trigger	Video motion detection (3 regions), External device through digital input, Sound detection,
Event Response	Notify control center, Change camera settings, Command other devices, E-mail notification with snapshots, Play the audio file, Push notification to mobile device, Save video to local storage, Upload video or snapshot to FTP server, Upload video to NVR server, Activate external device through digital output

Integration

Unified Solution	Fully compatible with ACTi software
GPS Position	Manual setting
ONVIF Compliant	Yes, Profile S, Profile G
GB28181 Compliant	Yes

Web Browser	IE 11
Auto Firmware Upgrade	Yes

Interface

Serial Port	1 x RS-232
Local Storage	MicroSDHC, MicroSDXC memory card slot (card not included)
Digital Input/Output	1/1

General

Power Source	DC 12V, PoE Class 2 (IEEE802.3af)
Power Consumption	4.32 W (PoE)
Dimensions	Main Unit (W x H x D): 75mm x 100.33mm x 30mm (3.0" x 4.0" x 1.2") Lens Unit (Ø x L): 26mm x 62.62mm (1.0" x 2.5")
Environmental Casing	Vibration proof (EN50155)
Mount Type	Bracket, Flush, Tilttable Flush Mount, Corner Mount
Starting Temperature	-20°C ~ 50°C (-4°F ~ 122°F)
Operating Temperature	-30°C ~ 60°C (-22°F ~ 140°F)
Approvals	CE, FCC, EN50155, UL (for optional PoE injector and power adapter)
Warranty	3 Year(s)

► Photo Indication



- 1 LED Indicators
- 2 Memory Card Slot
- 3 Digital Input/Output
- 4 Camera Input
- 5 Audio-In/Audio-Out
- 6 Ethernet Port
- 7 Serial Port
- 8 DC 12V Power Input
- 9 Reset Button

► Dimension Diagram

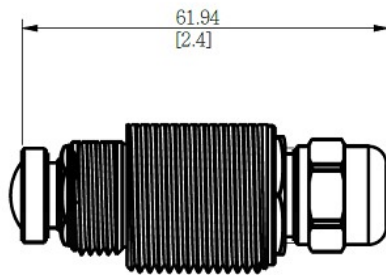
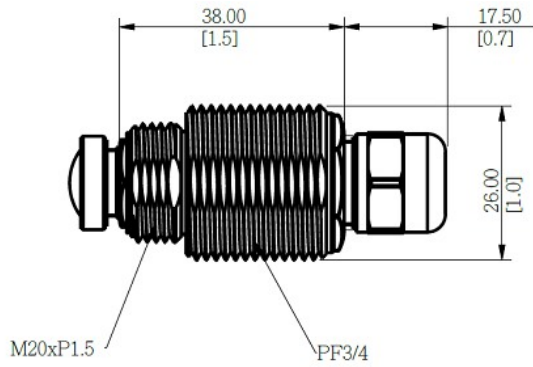

Unit: mm [inch]

▶ Related Products

Mounting Accessories - Camera Mount

PMAX-0403  Corner Mount for Covert and Pinhole Covert Cameras

PMAX-1016  Tiltable Flush Mount for Covert and Fisheye Covert Cameras

PMAX-1108  Bracket for all Covert Cameras (except L-Shape Pinhole)

R707-A0001  Bundled Flush Mount for Covert Camera

R707-A0007  Bundled Mounting Rail Kit for Covert Camera

Note: Some mounting accessories may need additional accessories for installation. Please check www.acti.com/mountingselector for more information.

Lenses - Fixed Lens

PLEN-0129  Fixed Focal f2.93mm, Fixed Iris F2.0, Manual Focus, D/N, Board Mount Lens

Power Supply Accessories - Power Adapter

PPBX-0011  Power Adapter AC 100~240V, with universal connectors for all DC12V powered devices

Network & Storage Peripherals - Data Switch

PPSW-0101  PLANET GS-4210-8P2T2S 8-Port Gigabit 802.3at Managed PoE Switch (PoE Budget 240W)

PPSW-0102  PLANET FGSD-1011HP 8-Port 802.3at PoE Switch (PoE Budget 120W)

PPSW-1101  PLANET GS-4210-24PL4C 24-Port Gigabit 802.3at Managed PoE Switch (PoE Budget 440W)

PPSW-3100  PLANET FGSW-1816HPS 16-Port 802.3at PoE Switch (PoE Budget 220W)

Extenders - PoE Extender

PPEX-0100  Veracity OUTREACH Max Power over Ethernet (PoE) Extender

Extenders - PoE over Coaxial Extender Kit

PPOC-0100  Planet LRP-101C-KIT Power over Coax Adapter Kit

Audio Devices - Microphone

PMIC-0100  Active Microphone Omnidirectional for all Cameras with Line-in Audio

PMIC-0201



Passive Microphone Omnidirectional for all Cameras with Mic-In Audio using Cable Wire or Terminal Connector, 2m cable

Installation Support - Camera Installation Kit

PMON-1001-010



Camera Installation Kit for use with iOS Device with belt bag, battery and charger (US, AC 110~240V)

PMON-1001-011



Camera Installation Kit for use with iOS Device with belt bag, battery and charger (Europe, AC 110~240V)

PMON-2000



Camera Installation Kit