

6/8/12-bay Turbo vNAS

TVS-x82 Series

A hyper-converged system with tiered storage, application-based partitioning and network traffic distribution

QNAP

4K2K UHD

Q vPC

Technology



Use your NAS as a PC

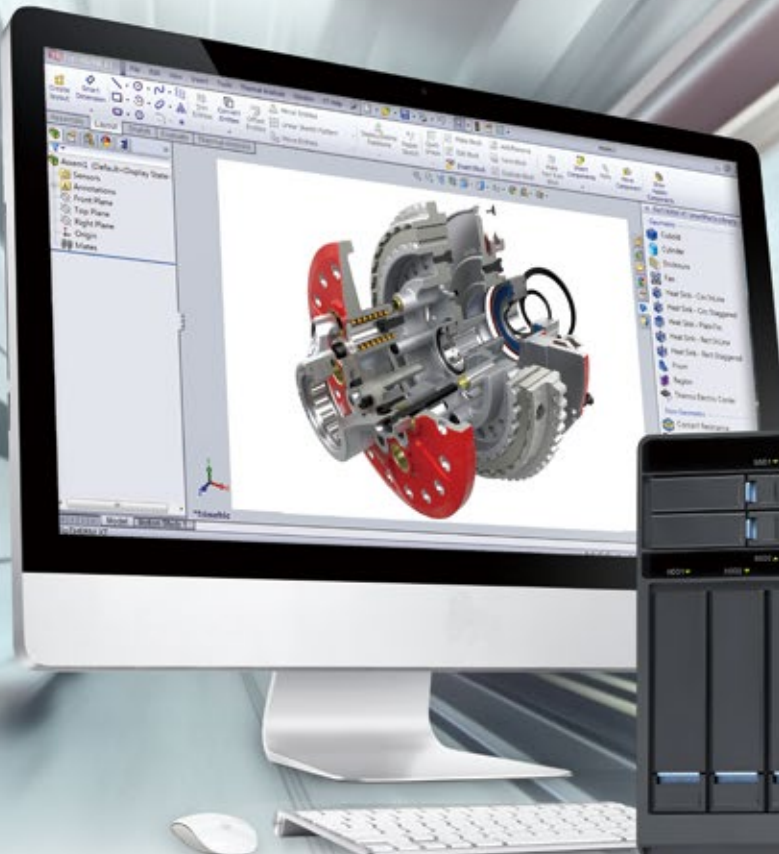

TVS-882-i5-16G-450W
TVS-1282-i5-16G-450W
TVS-1282-i7-32G-450W

450W models with AMD Radeon™ R9 Series GPU + GPU Passthrough technology for a premier 3D experience



TVS-1282-i7-16G-450W

Highlights of hardware capabilities

- 1 6th generation Intel® Pentium® or Core™ i3/i5/i7 multi-core processor provides up to 20% performance improvement
- 2 8GB (up to 32GB) DDR4 2133MHz RAM
- 3 USB 3.1 (10Gbps) Type-C expansion
- 4 40GbE and 10GbE network interfaces for high-speed sharing
- 5 M.2 SATA 6Gbps and SSD slots with support for PCIe NVMe SSD



- ◆ HDMI 2.0 ready, plays and transcodes stunning 4K 60 FPS videos
- ◆ Qmail Agent for secure and efficient email management of multiple email accounts
- ◆ Snapshot and Snapshot Replica provide continuous data protection
- ◆ Qtier™ with SSD Cache for around-the-clock acceleration
- ◆ Qsirch simplifies and accelerates searching on a QNAP NAS
- ◆ VJBOD (Virtual JBOD)
 - Online storage expansion with super-high-speed 40GbE networking
 - Achieves the best capacity utilization among multiple QNAP NAS units
 - On-demand, instant storage capacity allocation



TVS-1282



TVS-882



TVS-682

TVS-1282

Turbo vNAS

Hyperconverged infrastructure for next-generation performance and protection

Three PCIe expansion slots P.2

- ▶ PCIe Gen. 3 high-speed connection
- ▶ Support for 10/40 GbE adapters, PCIe NVMe SSD, external graphics cards, and USB 3.1 expansion cards

Four Gigabit Ethernet ports P.6

Ideal for service binding, port trunking and MPIO configurations

Three HDMI ports P.3

- ▶ Offers one HDMI 2.0 port and two HDMI 1.4b ports
- ▶ HDMI 2.0 fully supports stunning 4K (60 FPS) videos
- ▶ Dual HDMI output with duplicated and extended desktop options

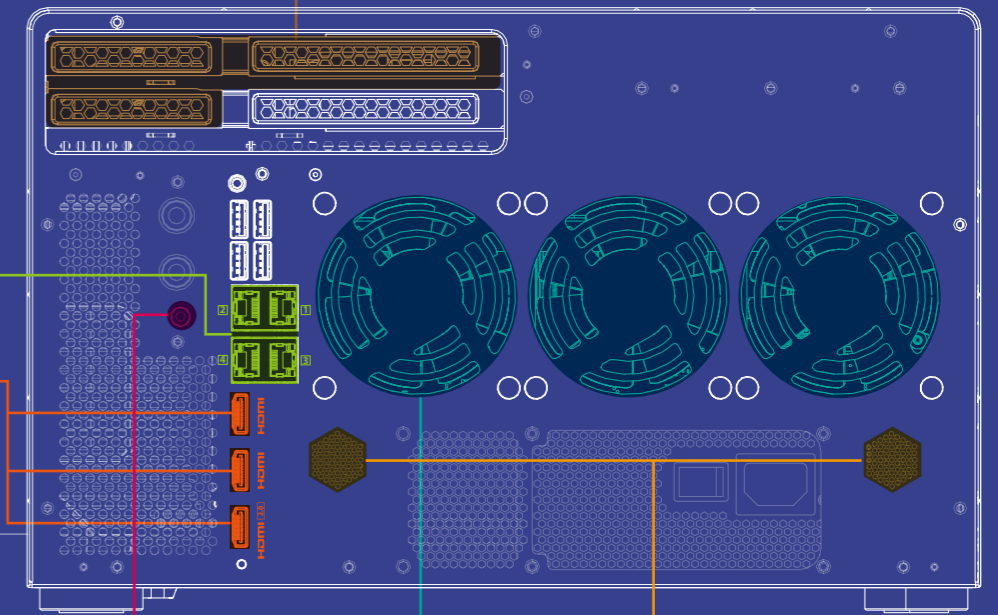

P.2 Smart fans for quiet operation

Separately detect the CPU and HDD temperatures to dynamically control fan speed.

P.4 3.5mm audio jack

Connects to a speaker or a headphone for audio output

P.4 Two built-in speakers

- ▶ For direct audio output
- ▶ Provides verbal system warnings

Rear View

Side View

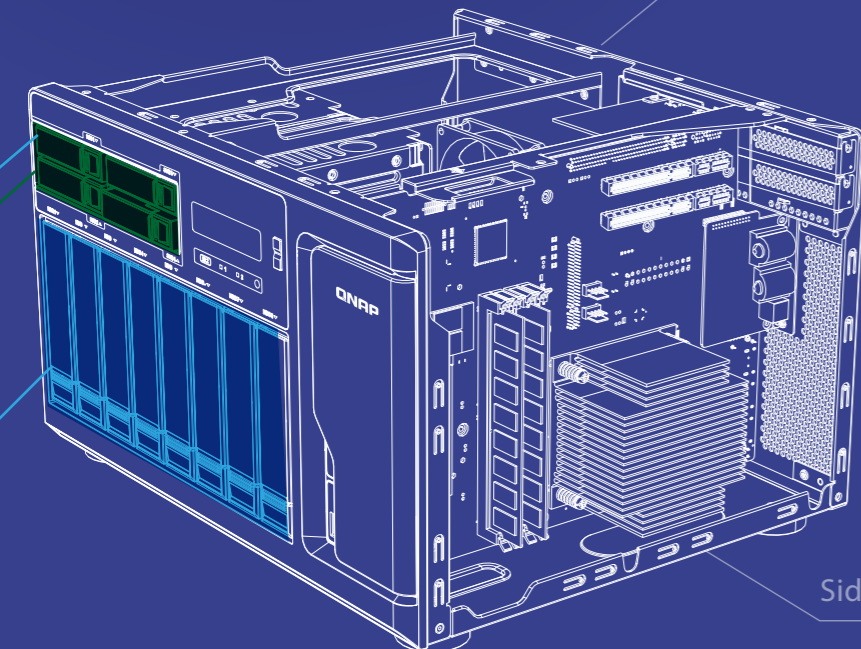

P.1 Four built-in SSD 2.5" slots

Offers flexible configuration in tiered storage and enables cache acceleration

P.2 Tool-less HDD tray and installation

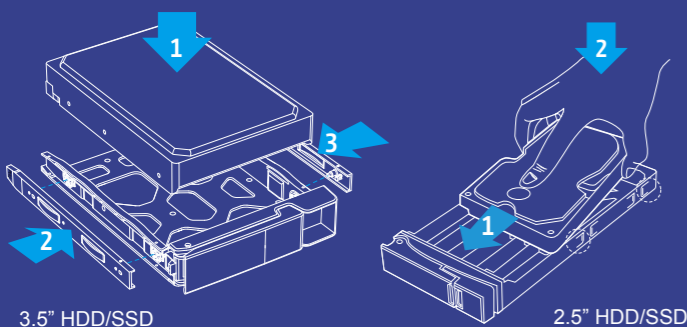

3.5" HDD/SSD

2.5" HDD/SSD

Two built-in M.2 slots* P.1

- ▶ Supports SATA 6Gb/s M.2 SSDs with 2242, 2260, 2280, and 22110 form factors
- ▶ Allows for the best flexibility in tiered storage configuration and enables cache acceleration

* M.2 SSD is optional

DDR4 2133 MHz memory P.1

Supports four DDR4 memory modules with a maximum of 32GB in total

6th Generation Intel® Core™ Processor P.1

Featuring the latest 14nm manufacturing technology with faster buses to support DDR4, PCIe Gen. 3, and DMI 3.0 for incredible performance and extremely efficient data transmission.

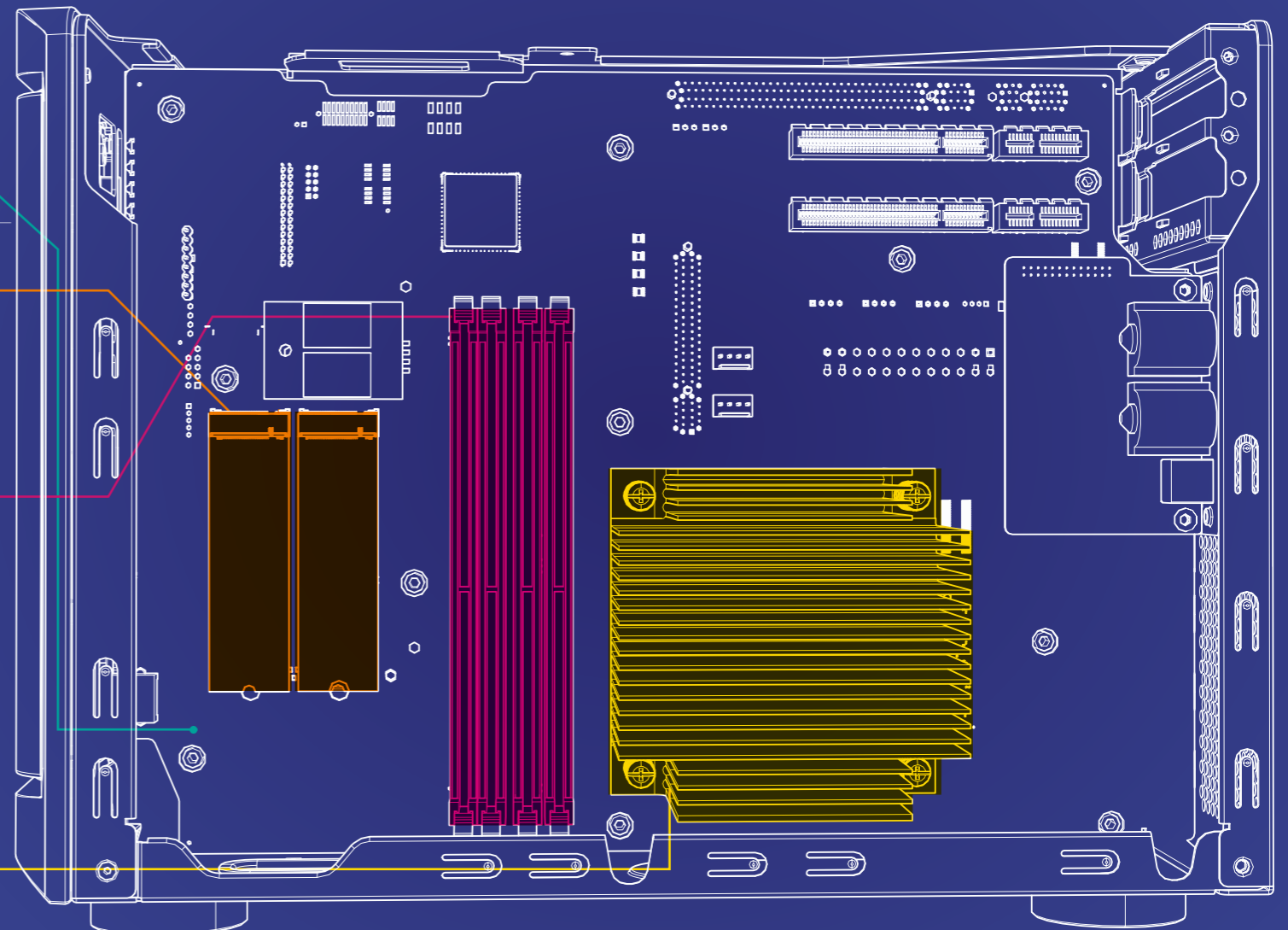

TVS-882 Turbo vNAS

(TVS-882 and TVS-682)

TVS-682 Turbo vNAS

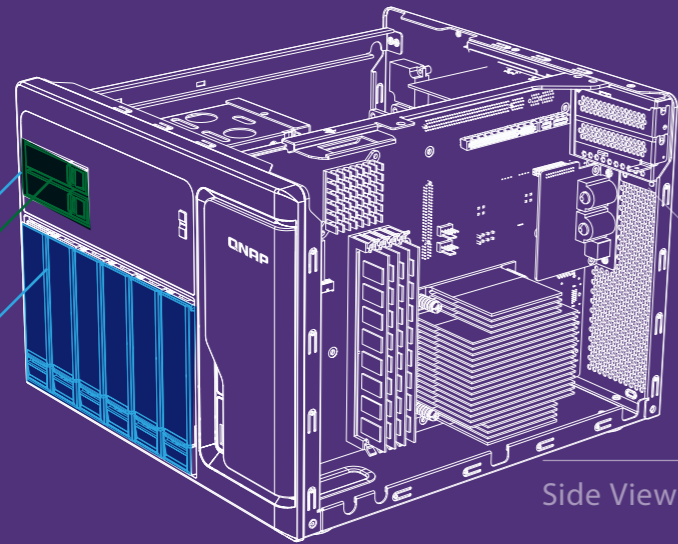

Side View

P.1 Built-in two SSD 2.5" slots

Offers flexible configuration in tiered storage and enables cache acceleration

P.2 Tool-less HDD tray and installation

Rear View

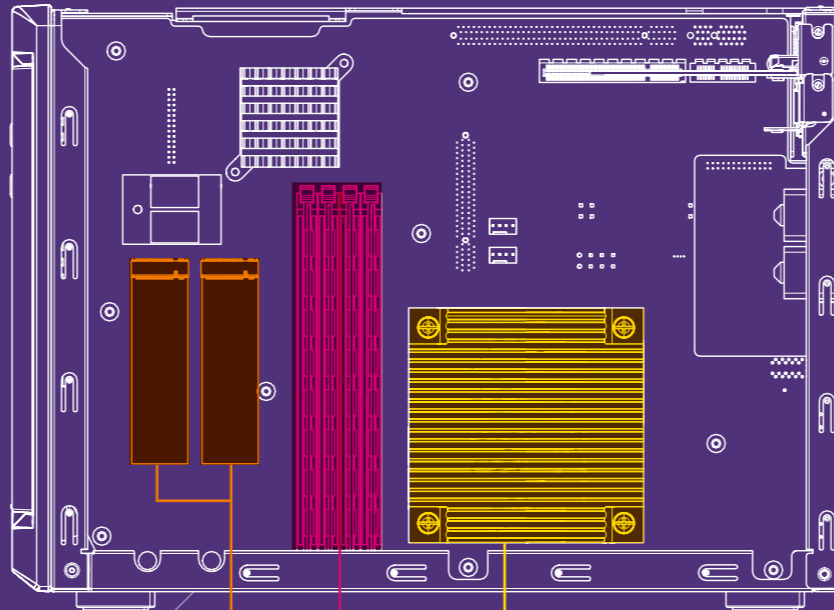

P.1 Built-in two M.2 slots*

- ▶ Supports SATA 6Gb/s M.2 SSDs with 2242, 2260, 2280, and 22110 form factors
- ▶ Allows for the best flexibility in tiered storage configuration and enables cache acceleration

*M.2 SSD is optional

P.1 DDR4 2133 MHz memory

Supports 4 DDR4 memory modules with a maximum of 32GB in total

P.1 6th Gen. Intel® Core™ Processor

Featuring the latest 14nm manufacturing technology with faster buses to support DDR4, PCIe Gen. 3, and DMI 3.0 for incredible performance and extremely efficient data transmission

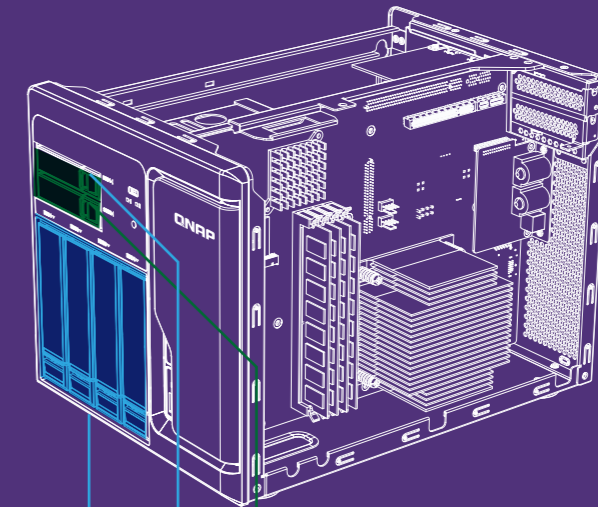

Rear View

P.1 Built-in two SSD 2.5" slots

Offers flexible configuration in tiered storage and enables cache acceleration

P.2 Tool-less HDD tray and installation

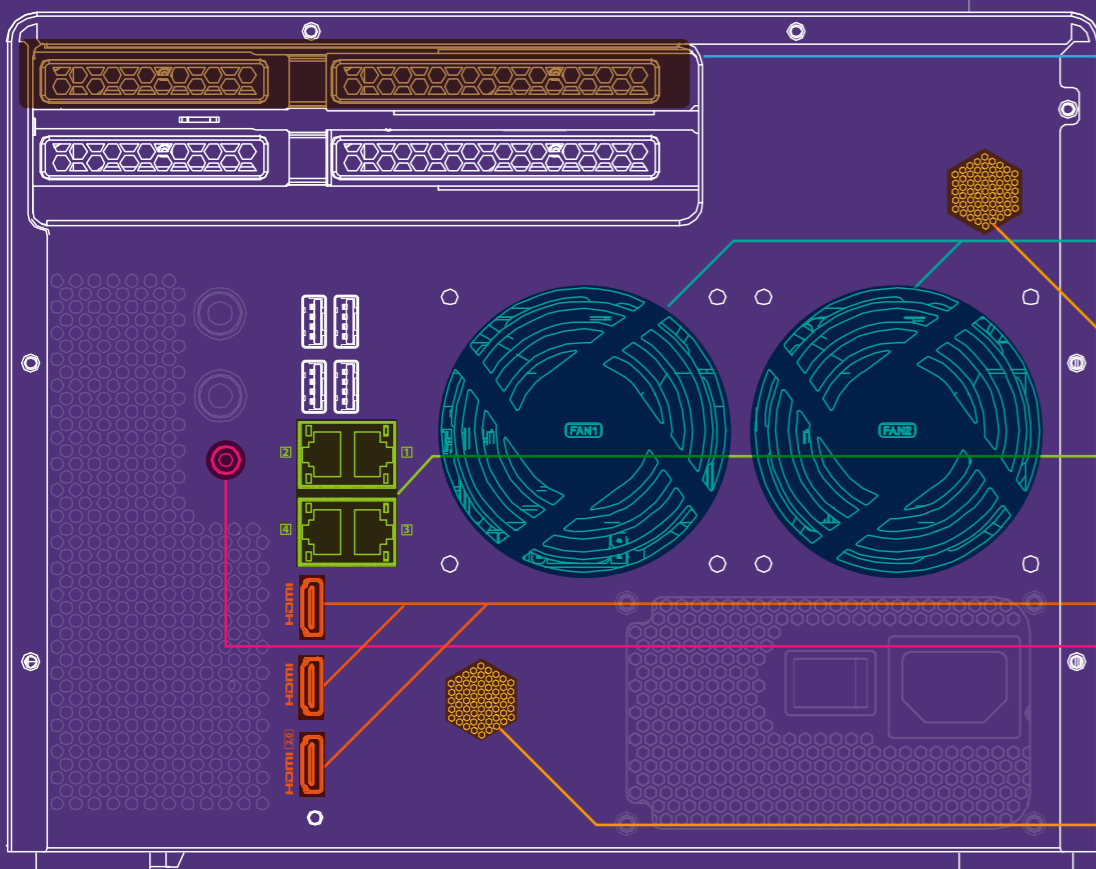

P.2 Two PCIe expansion slots

- ▶ PCIe Gen. 3 high-speed connection
- ▶ Support for 10/40 GbE adapters, PCIe NVMe SSD, external graphics cards, and USB 3.1 expansion cards

P.2 Smart fans for quiet operation

Separately detect the CPU and HDD temperatures to dynamically control fan speed
(TVS-882 has 2 system fans whereas TVS-682 has 1 system fan)

P.6 Four Gigabit Ethernet ports

Ideal for service binding, port trunking, and MPIO configurations

P.3 Three HDMI ports

- ▶ Offers one HDMI 2.0 port and two HDMI 1.4b ports
- ▶ HDMI 2.0 fully supports stunning 4K (60 FPS) videos
- ▶ Dual HDMI output with duplicated and extended desktop options

P.4 3.5mm audio jack

Connects to a speaker or a headphone for audio output

P.4 Two built-in speakers

- ▶ For direct audio output
- ▶ Provides verbal system warnings

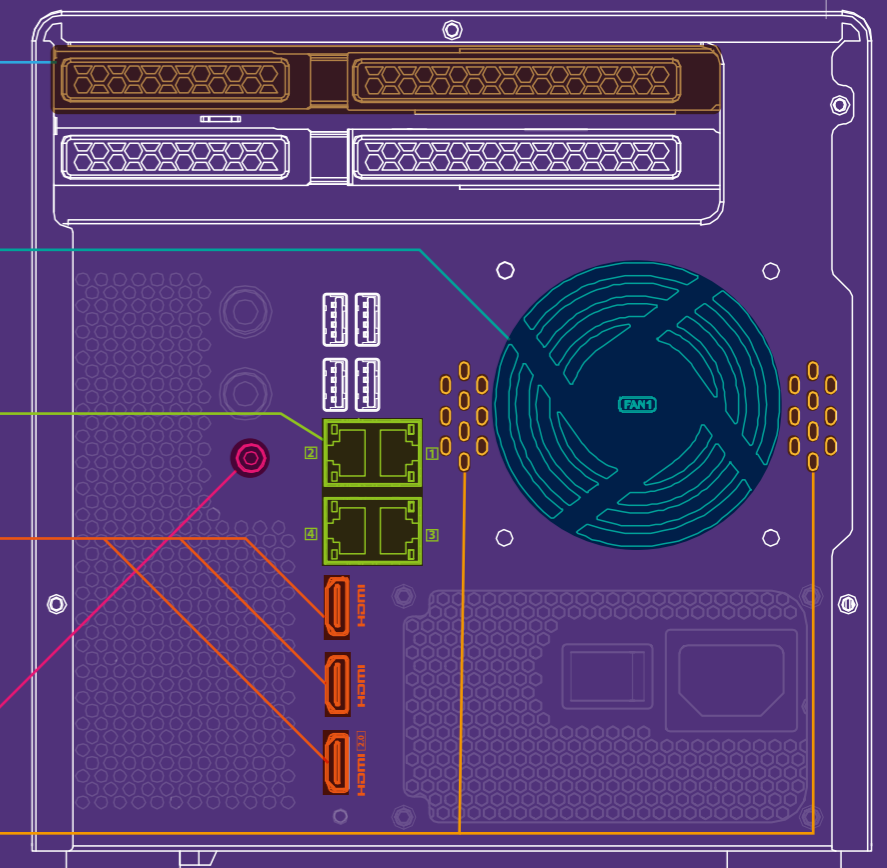

Hardware Introduction

6th Gen Intel® Core™ processor family

The 6th Gen. Intel® Core™ processor family harness the power of Intel's leading 14nm process. Along with a more advanced chipset and faster buses, they provide a significant leap in NAS performance and power efficiency, supporting more concurrent apps on the NAS and accomplishing more tasks in less time. The 6th generation Intel® Core™ i3/i5/i7 processor features PCIe Gen.3, Direct Media Interface (DMI) 3.0 (Gen.3 x4) and DDR4 2133MHz dual-channel memory. 6th Generation Intel Core™ processors deliver 20%-30% better performance compared to previous generation processors. In addition, major improvements to the hardware architecture enables the Thunderbolt™ link to be directly interfaced with the CPU, saving DMI bandwidth while improving the overall read speed with about 20% and write speed with about 35% performance improvement.

1st generation Thunderbolt NAS

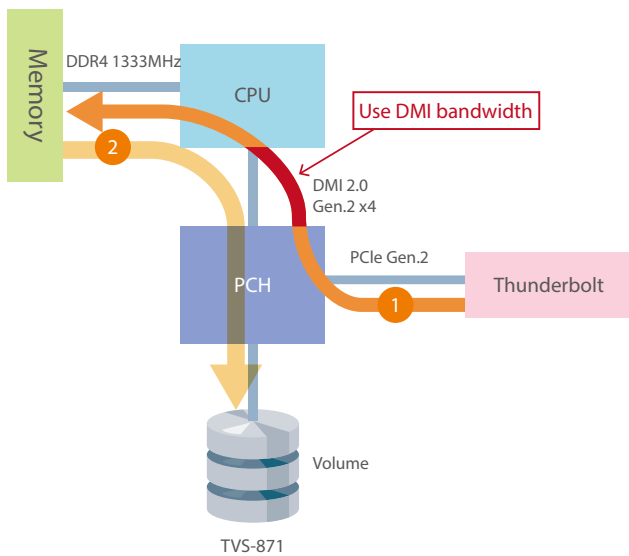

2nd generation Thunderbolt NAS

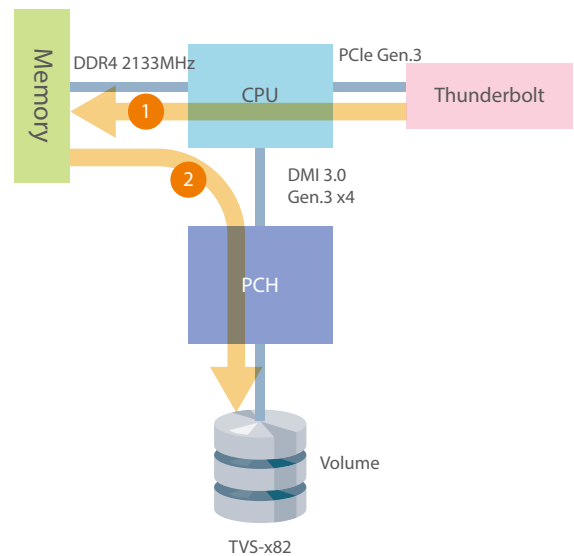

M.2 SATA 6Gb/s and 2.5" SSD slots

The TVS-x82 series has three types of storage technologies including two built-in M.2 SATA 6Gb/s and 2.5" SSD slots. (The TVS-682 and TVS-882 support two 2.5" SSD slots whereas TVS-1282 supports four 2.5" SSD slots.) The M.2 SSD replaces the mSATA standard and offers more flexible physical specifications and comparable performance with a smaller physical size. M.2 SATA and 2.5" SSD efficiently optimizes performance and reduces costs in multi-tier configurations with Qtier (QNAP's auto-tiering technology).

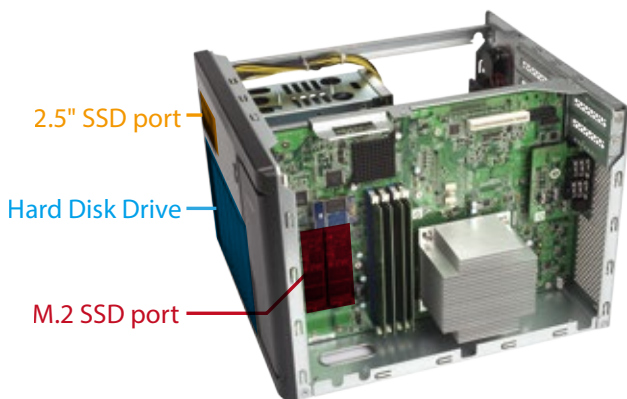

The use of M.2 SSD on the system

Which M.2 physical specifications are supported on the TVS-x82?

The TVS-x82 series supports 2242, 2260, 2280 and 22110 form factors with B-key edge connectors.

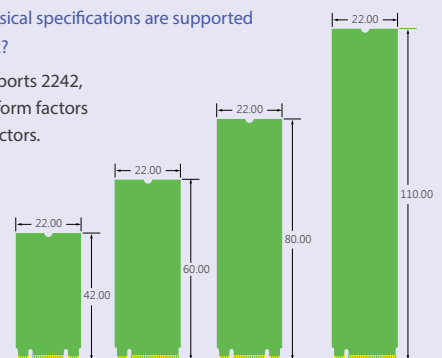

In addition to enabling cache acceleration with the M.2 SSD, what are some other ways to utilize the M.2 SSD on the TVS-x82?

- **Secure, encrypted, and isolated storage space**

Unlike the HDD drive bays, the M.2 SSD is not accessible without opening the chassis. Plan a dedicated volume with the M.2 SSD to store sensitive or critical data and further help protect the data when paired with hardware-assisted volume encryption.

- **System Volume**

Compared with conventional HDDs, M.2 SSD provides higher performance in random access with seamless responsiveness. Hence, deploy the QTS (NAS operating system) on the M.2 SSD to increase overall system performance and responsiveness.

PCIe Gen. 3 super-high-speed expansion

The PCIe expansion of the TVS-x82 fully supports PCIe Gen.3 standard with an incredible bandwidth of 1 GB/s per lane (double the bandwidth of the previous PCIe Gen.2). With PCIe Gen. 3, the TVS-x82 provides expansion opportunities for a variety of high-quality 10GbE/40GbE network cards, USB 3.1 expansion cards, PCIe NVMe SSDs and even professional graphics cards that are powerful in gaming or professional applications.



TVS-x82 PCIe expansion

NAS Model	PCIe Spec
TVS-682	1*PCIe Gen.3 x16, 1* PCIe Gen3 x4
TVS-882	1*PCIe Gen.3 x16, 1* PCIe Gen3 x4
TVS-1282	1*PCIe Gen.3 x8, 2* PCIe Gen3 x4

Dedicated graphics card slot

Normally high-performance graphics cards demand high-capacity heatsinks and fans. The TVS-x82 system not only supports full-height PCIe expansion cards but also accommodates high-performance, professional graphics cards.

Dedicated slot for high-performance graphics cards

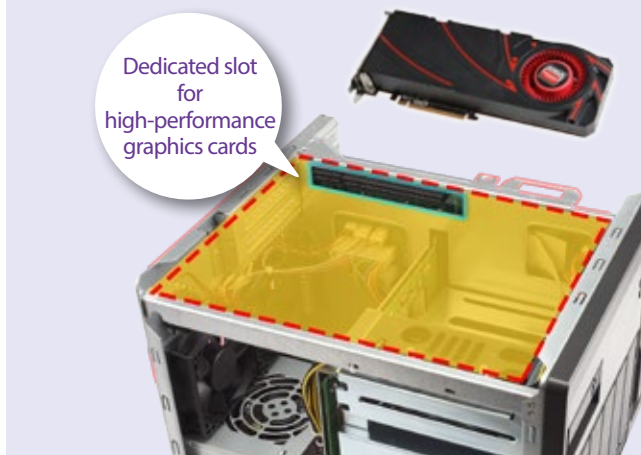

Multi-zone heat dissipation for quieter operation

As the number of software features on NAS increases, the greater the number of apps and background tasks that will be running. However, the power required to run an increasing number of workloads also produces more heat. The multi-zone heat dissipation employed in the TVS-x82 enables the dynamic adjustment of the system fan and CPU fan speeds in different zones of the system. Along with the multi-zone smart fan settings of QTS, the system provides you with a quiet, stable, and high-performance for optimal video post-production and multimedia playback.

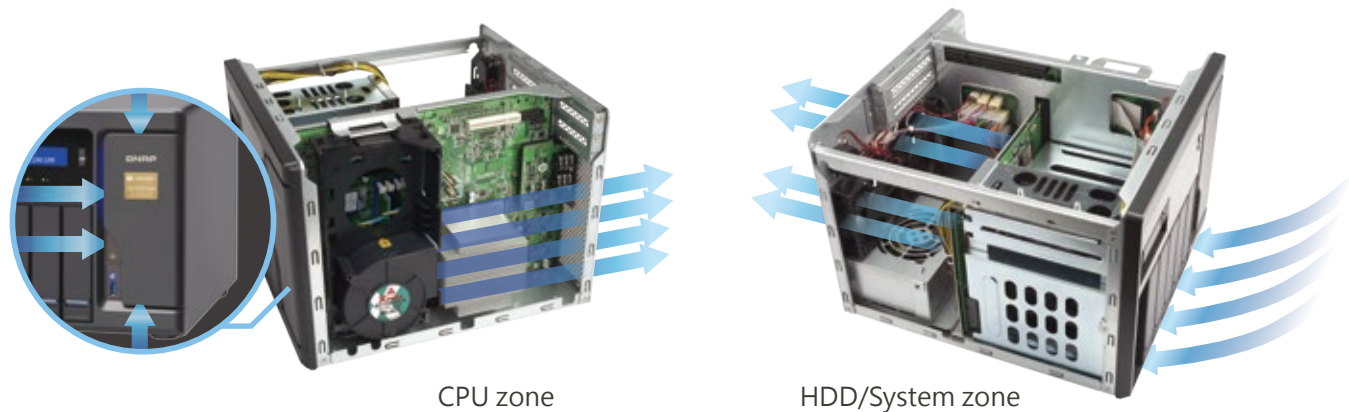

Quick, tool-less HDD installation with snap-in HDD mounts/guides

The fast and easy HDD installation employed on the TVS-x82 allows you to install HDDs with only a few steps, saving you time and effort on system setup and maintenance. All of the HDD trays come with a lock to protect against accidental removal.

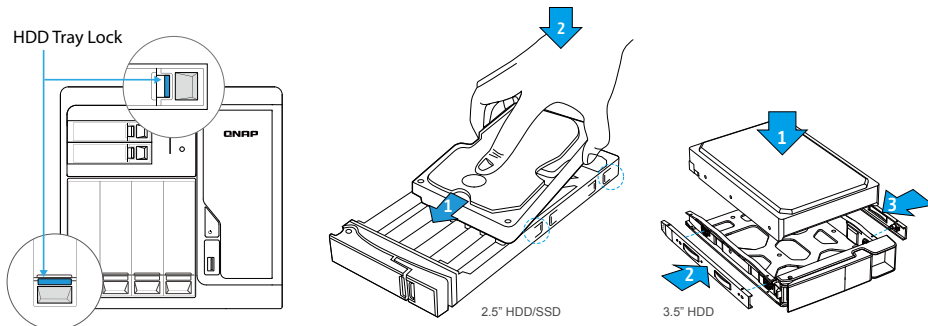

Triple-HDMI output for multi-zone streaming

The TVS-x82 has one HDMI 2.0 and two HDMI 1.4b outputs, enabling you to increase your productivity by multi-tasking across multiple monitors or to mirror content to a second screen.

Enjoy a multitude of supported apps, such as Kodi™, HD Player, Plex Home Theater®, YouTube™, Spotify®, JRiver®, Google Chrome™, Mozilla Firefox® and many more on HD Station via HDMI output. In addition to using your NAS as a multimedia player, you can install various open-source applications on the Linux® Station, which seamlessly integrates a Linux OS with QTS.

 To build a Linux desktop environment, please install the Linux Station from the App Center.

* The default is extended mode for multiple displays.
 ** Remote desktop currently does not support audio output.



Max. Number of Supported HDMI Outputs	Maximum Resolution
Single HDMI (2.0) output	4096 x 2304 @60Hz
Two simultaneous HDMI output	2880 x 1800 @60Hz
Three simultaneous HDMI output	2304 x 1440 @60Hz

 Due to hardware restrictions, the highest resolution that can be attained when all three HDMI ports are used simultaneously will be reduced.

Enhanced multimedia enjoyment with HDMI 2.0

Videos come to life in true 4K 60 FPS so users can enjoy amazing and vibrant multimedia experiences on 4K displays through the HDMI 2.0 port or the two HDMI 1.4b ports. The two HDMI 2.0 ports offer 18Gbps bandwidth to support smooth playback of 4K (4096 x 2304) 60 FPS - 4 times the resolution of 1080p. Combined with the Kodi™ player on HD Station and optional remote control, the TVS-x82 allows you to enjoy multimedia content by connecting an HDTV or A/V receiver to the HDMI ports.



HDMI 2.0

is available now



Direct music output through the built-in or external speakers

The TVS-x82 has two built-in speakers and one Line-Out port for direct audio output. It is as convenient as having your personal music player. To select the audio output source in Music Station, File Station or HD Station, please select "Line-out/Speaker" in the "Select Output Device" menu. The alarm buzzer now also features verbal alerts instead of a "beep" sound, providing more precise alerts regarding system events.

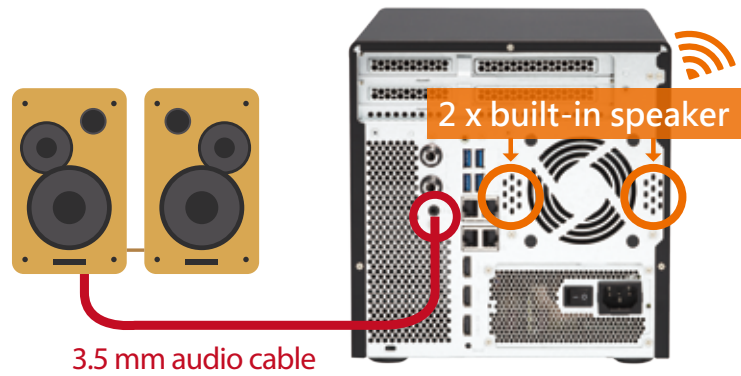

Note:

1. Only one of the above mentioned audio output ports can work at one time. If external speakers are connected, the sound will be output through those speakers.
2. To enable or disable system warnings, go to "System Settings" > "Hardware" > "Buzzer".
3. Verbal system warnings are only available in Chinese and English.

Remote control with customization options

The TVS-x82 comes with the optional purchase of an infrared remote control to make using HD Station easier. In addition, you can install Qremote on your mobile devices to transform them into handy remote controls. HD Station also offers remote control learning and memorization for you to customize your remote control settings.



How to configure the "Custom Remote" on HD Station? Remote control with customization options

Just follow these two steps to pair your remote control with the NAS:

1. Log into the NAS as an administrator and go to "HD Station" > "Settings" > "Preferences", and then select "Custom Remote" to configure a new customized remote control.
2. Press and hold the corresponding buttons until the progress bar shows that the progress is complete.

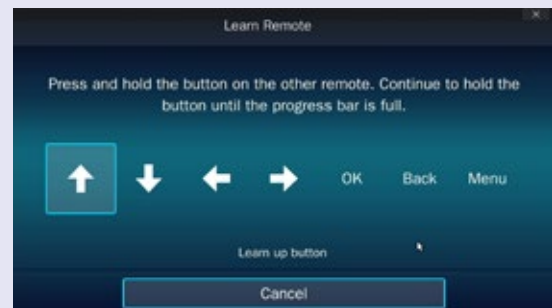
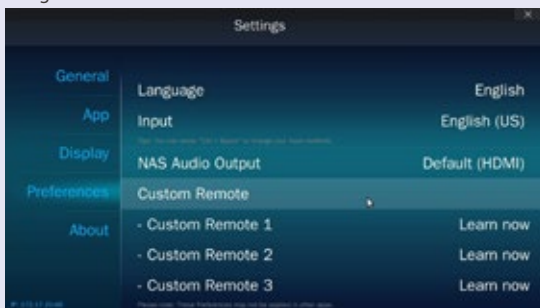

System requirements:

1. HD Station 3.1.1 (or newer).
2. A maximum of 3 customized remote controls can be used at one time.
3. Some remote controls are not customizable.

Perfect Storage Trio: Tiered Storage, Application-Based Partitioning and Network Traffic Distribution

High-performance hardware, well-designed application functionalities and thoroughly-planned usage scenarios are three distinctive cornerstones for achieving optimum performance. QNAP now introduces the key system performance optimization trio: tiered storage, application-based partitioning and network traffic distribution that are especially combined for the TVS-x82 series, facilitating optimized storage deployment based on different usage scenarios.

Tiered Storage

Storage media directly determines the highest possible write speeds, but high-speed storage media are always the expensive option. As data used in modern business becomes increasingly diverse, deploying a reliable, high-performance, top-quality, large-capacity and cost-effective storage solution can be a formidable challenge facing enterprises. Therefore, a tiered storage system (tiering based on the system performance and capacity) can more efficiently process data of different types, largely boosting overall operational efficiency for enterprises. The TVS-x82 series supports three storage methods (M.2 SATA 6Gb/s, 2.5" SSD and SATA HDD) and also supports ultra-high speed PCIe NVMe SSD.



M.2

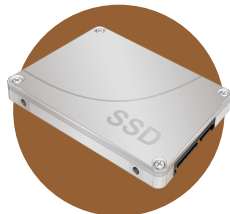

SSD



SATA HDD



PCIe NVMe SSD

Tiered Storage

	Tier 0 Storage	Tier 1 Storage	Tier 2 Storage
Device Used	PCIe NVMe SSD	M.2 SATA 6Gb/s and SSD	SATA HDD
Needs	Low latency and high performance but with lower capacity	Performance, capacities and availability	Lower performance, larger capacity, cheaper
Usage Scenarios	Online transaction processing (OLTP) database, online analytical processing (OLAP)	Online database server, ERP database	Email server, snapshots, online archiving, large amounts of data
Data Usage Examples	Records and logs, paging file metadata or index file, replication of VM and VDI connections, merging of I/O and performance	Operating files, emails, networks, database tables, audio, video, VM and VDI, hosts	Main directory, data acquisition, disk-to-disk (D2D) backup/restore
Data Status	Operating data	Mainly operating data	Mixed with operating and idle data
Measurement Standard	Focuses on high IOPS and low latency, low capacity needs; high cost	Focuses on IOPS, bandwidth, reliability and low capacity needs	Focuses on capacity and reliability; cost is relatively low for high-density capacities.

Qtier + Cache = 24/7 Acceleration

Qtier™ empowers automated-tiering storage solutions that can automatically move frequently-accessed "hot" data to high-performance storage tiers and infrequently-accessed "cold" data to lower-cost, higher-capacity drives according to schedules, allowing businesses to enjoy exceptional application performance and lower TCO of storage at the same time.

SSD cache technology can move hot data to the SSD tier in real time based on data access frequency. Leveraging Qtier and SSD technologies, the TVS-x82 series NAS can ensure 24/7 acceleration for performance optimization.

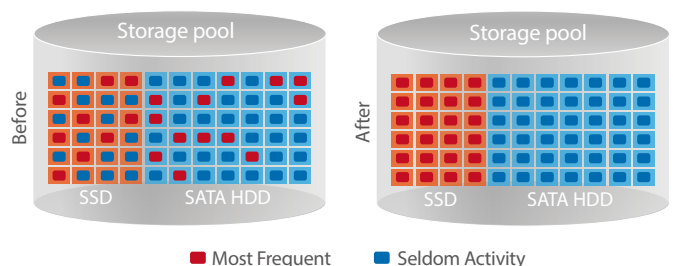

Comprehensive storage combination

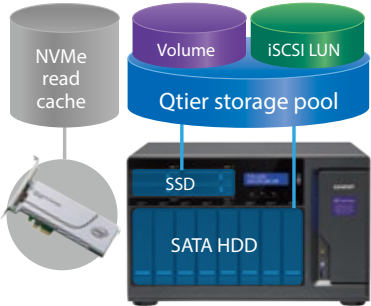
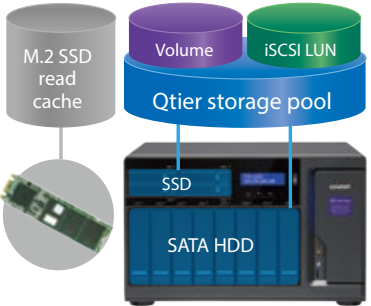
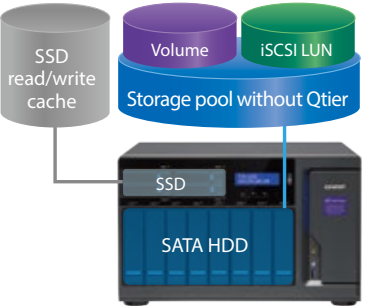
<p>A Use PCIe NVMe as the read cache and SSD+SATA HDD as the storage pool for Qtier</p>	<p>B Use M.2 as the read cache and SSD+SATA HDD as the storage pool for Qtier</p>	<p>C Use SSD as the read/write cache and SATA HDD for general purpose storage pool</p>
		
<p>Application scenario: Ultra-high speed 24/7 accelerated performance with medium amount of data variation, coupled with instantaneous large number of connections; typical example: news website database.</p>	<p>Application scenario: affordable 24/7 accelerated performance.</p>	<p>Application scenario: simultaneous accelerated read and write performance and ideal for large data volumes and huge changes in content that require a fast response to hot data movement; typical example: video editing.</p>

Application-based Partitioning

QTS provides diverse applications and each application has different performance requirements. For example, to ensure the integrity of recordings, Surveillance Station requires higher-priority access to storage media, while normal transmission speeds are sufficient for file sharing. However, when multiple applications are running on the same storage media, the required throughput level cannot be guaranteed as the storage media is busy handling I/O requests from all of them. The TVS-x82 series supports three different types of storage media: M.2, SSD and SATA hard drives and they can be configured as independent partitions for different applications, ensuring the throughput level for each application.

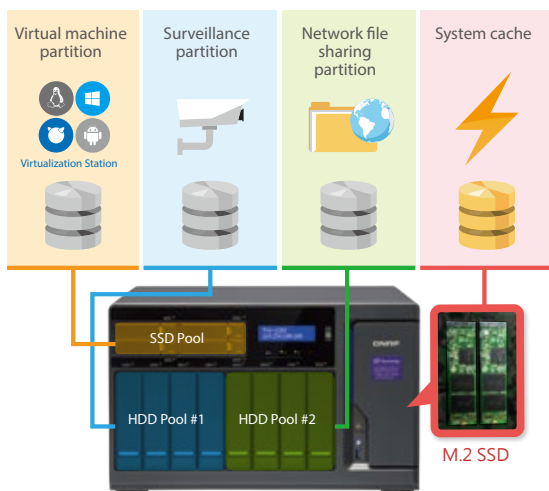

Network Traffic Distribution

Network bandwidth essentially dictates the I/O performance for all NAS services. If every application and service uses the same network interface, the required bandwidth cannot be guaranteed for important applications and applications that consume large bandwidth will probably use most of the available bandwidth. For example, if the surveillance system, virtual machine, and file sharing service all use the same network interface, the surveillance system is likely to drop frames. Therefore, network traffic distribution becomes extremely important. With four 1GbE NIC and two 10GbE NICs, the TVS-x82 series allows applications to use dedicated interfaces to meet network traffic distribution requirements. Network interfaces can also be easily managed with the Network & Virtual Switch app.

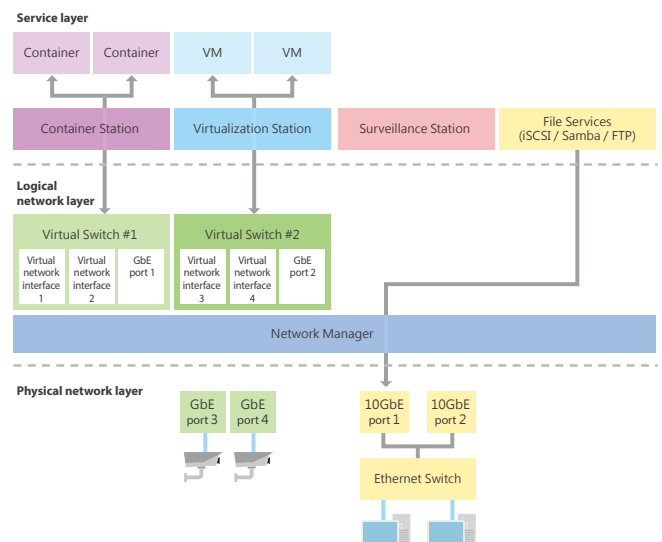



Snapshot

Block – level local snapshot and snapshot replica — An efficient and economical way to protect files

QNAP's Whole Volume/LUN Snapshot Agent records the status of files using the Copy on Write mechanism. This helps in recovering files to a previously saved state in case of accidental deletion or modification and meeting enterprise requirements of improving Recovery Point Objective (RPO) and Recovery Time Objective (RTO).

Benefits of QNAP Snapshot Technology

The block-based QNAP Snapshot Technology supports up to 256 snapshots for each volume or LUN, up to 1024 snapshots. You can schedule snapshots hourly, daily, weekly, monthly, or yearly to meet enterprise requirements of improving Recovery Point Objective (RPO) and Recovery Time Objective (RTO). Further, the smart snapshot function can assist in saving space and reserve snapshots for future use. Additionally, Snapshot Agent ensures data integrity on locked or open files while taking snapshots.

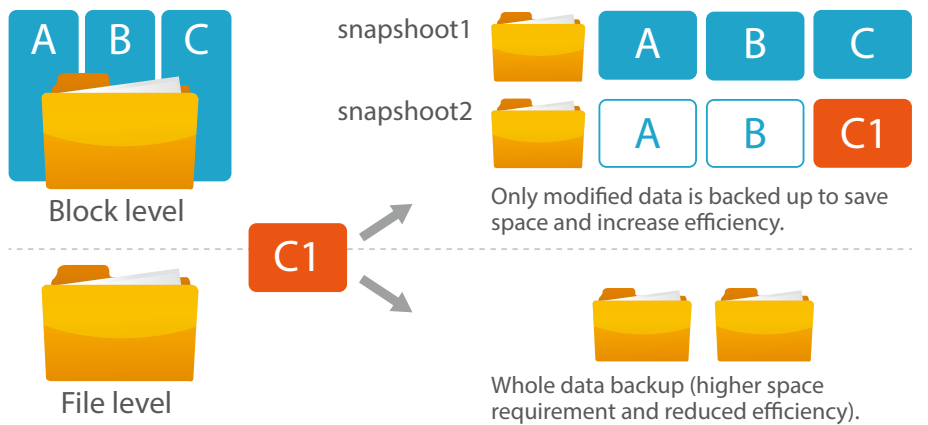

Only modified data is backed up to save space and increase efficiency. Whole data backup (higher space requirement and reduced efficiency).

	Snapshot Replica	RTRR	Rsync	NAS to NAS
Backup level	Volume / LUN	Shared Folder	Shared Folder	Shared Folder
Transmission mode	Block-based	File-level file-based	File level block-based	File-Level block-based
Backup scheme	Only back up modified file	Re back up whole file	Compare source and destination files and transmit only changed data blocks	
Time	Scheduled	Real time/ Scheduled	Scheduled	Scheduled
Encryption	Supported	Supported	Supported	Supported
Compression	Supported	Supported	Supported	Supported
Memory Requirement	4GB RAM Required	No Requirement	No Requirement	No Requirement
Remote System	QNAP NAS	QNAP NAS	Rsync Server	QNAP NAS
Using Scenario	<ul style="list-style-type: none"> Lot of small data Large file that need continues modification (VM image or backup image) 	<ul style="list-style-type: none"> Real time replication or synchronization Fast transmit within local LAN 	<ul style="list-style-type: none"> Large file that need continues modification Transmit in long distance 	

Local snapshot to provide continuous data protection

File-level recovery

The low-impact, small-sized, and user recoverable snapshots offer more benefits of storage administration compared to traditional file copies, which are often stored as a single large data file. For instance, you can choose to recover a file in a folder or the entire folder instantly with a few clicks.



High flexibility

Snapshots can be used with iSCSI LUNs and Volumes in QNAP NAS and expansion units to achieve full protection. On the other hand, Snapshot Replica allows you to transfer your snapshot to a remote QNAP NAS for backup.

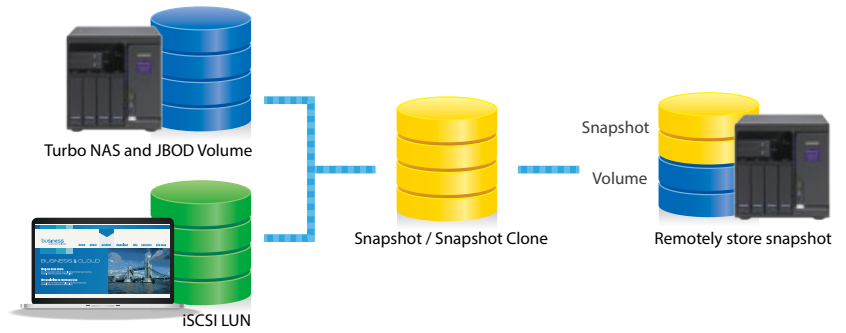

Intuitive and user-friendly interface

The QNAP Snapshot provides tools in Storage Manager to help you find specific files to recover. You can easily view files and folders in a snapshot and browse through different snapshots displayed in chronological order. In addition, file recovery just takes a few clicks, increasing operational efficiency.

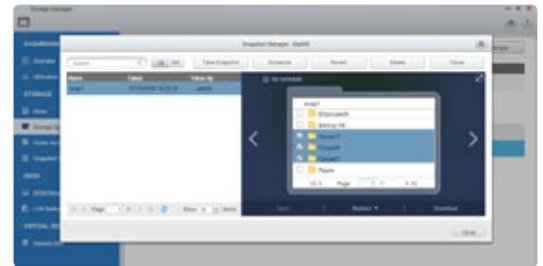

Snapshot clone

Clone a snapshot as a volume or LUN for quick file access, eliminating long restore times and reserving sizeable space for storing backups.

Rsync/RTRR integration

The Rsync/RTRR functions in Backup Station automatically detect whether the system supports Snapshots. The RTRR/Rsync function take snapshots of the volume before starting replication and then back up snapshots to a remote server. This greatly enhances data integrity.

Windows previous versions can keep up to 256 versions

Snapshots enable Windows users to restore files directly using the Windows previous versions feature in Windows explorer, to save time and effort without requiring IT administrators' support.

Note: The maximum versions allowed depends on the storage space. QNAP Snapshot Technology supports up to 256 snapshots for each volume or LUN, up to 1024 snapshots.

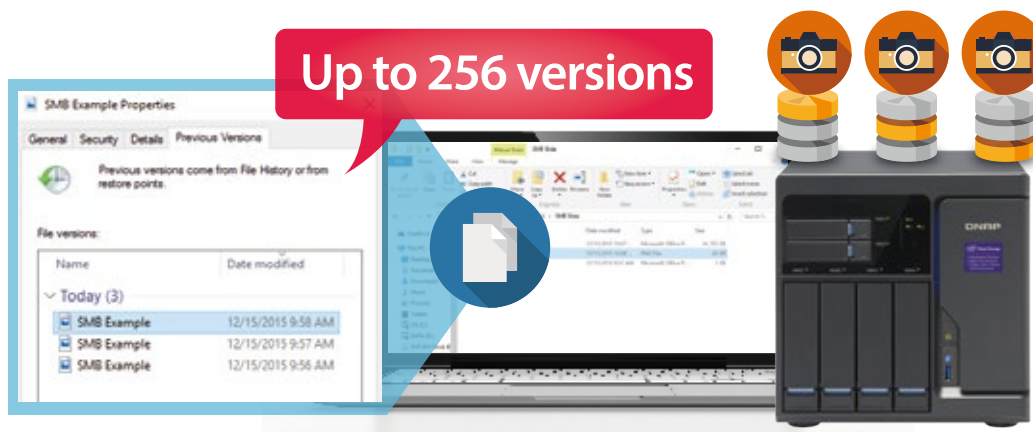

Remote Snapshot Replica prevents data loss



Snapshot replica

The Remote Snapshot Replica enables you to replicate volume/LUNs between different remote servers using snapshot technology, which helps to reduce storage consumption and bandwidth. Either take the snapshot immediately or set up a snapshot schedule. It is considered one of the most comprehensive strategies for data backup.

Snapshot Vault

Snapshot Vault is an essential component of a comprehensive data backup strategy for organizations with a global footprint aiming to achieve a boundary-less datacenter. Snapshot Vault is your backup center for storing and managing every snapshot created remotely from another QNAP NAS. Snapshot Vault fully supports cloning a snapshot.

NAS-to-NAS snapshot replica

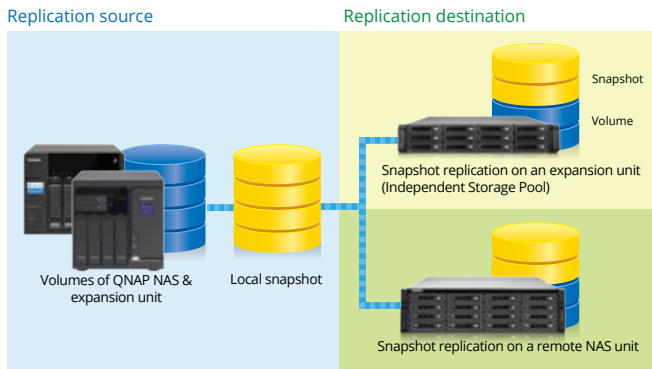

One-to-Many & Many-to-One snapshot replication

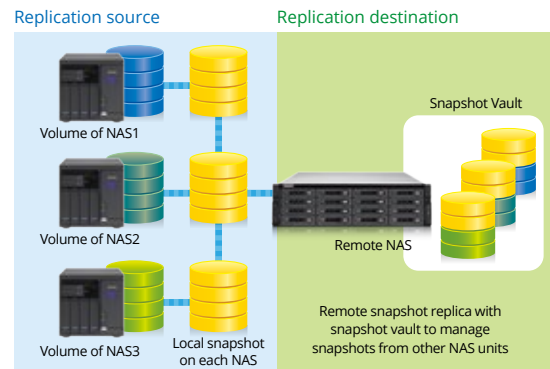

Managing snapshots remotely from another NAS

Use the Clone function to clone (or mount) a snapshot from the Snapshot Vault as a volume or iSCSI LUN on a QNAP NAS. Directly access these files through File Station or Backup Station. Use an iSCSI initiator to connect to a cloned iSCSI LUN from another computer.

Replication settings

To minimize the risk of data breach, the Snapshot Replica provides the option of file encryption. It also provides file compression and transfer rate adjustment to lower bandwidth consumption.

Application consistent snapshots with Snapshot Agent

Snapshot Agent, used for iSCSI LUN, allows connecting the Turbo NAS with the remote servers (VMware vCenter or Windows Server) to ensure consistent snapshots. On those remote servers, the running applications (VMware virtual machines, Hyper-V virtual machines, SQL server, Windows file server...) will write/flush the data from the memory to the iSCSI LUN prior the snapshot is taken. The application will then be consistent and include all necessary data. In case of snapshot restoration, no data will be missing.

VSS Hardware Provider work flow

The system may temporarily stop operating while flushing data to the LUN

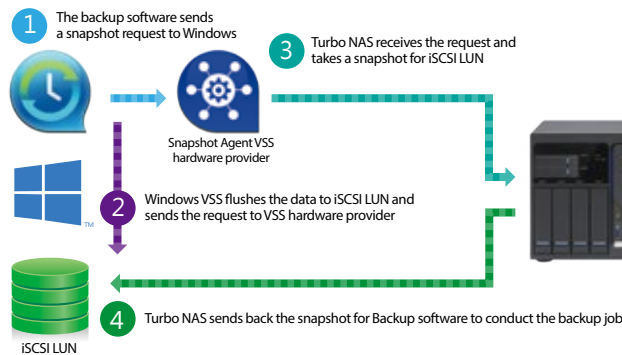

Snapshot Agent work flow

The system may temporarily stop operating while flushing data to the LUN

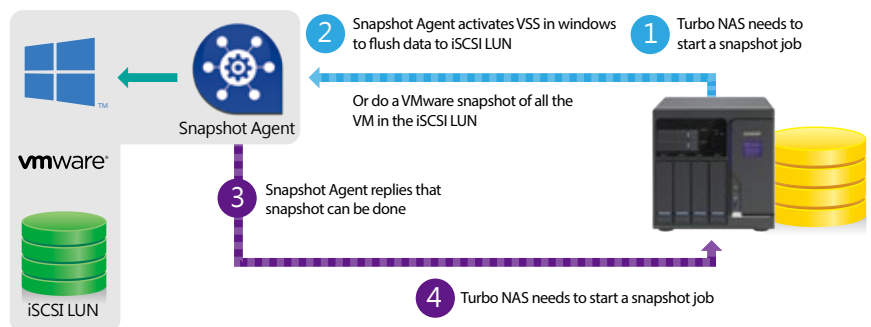

Virtual JBOD

Achieve the best capacity utilization among multiple QNAP NAS units

When I have multiple QNAP NAS units, or when I need to expand capacity on demand, how do I achieve the best utilization of NAS storage? Use QNAP VJBOD (Virtual JBOD) to utilize storage resources of other QNAP NAS. VJBOD enables you to create virtual storage pools and volumes on your local NAS. This will enable you to achieve the highest storage utilization of the multiple QNAP NAS in your environment.

On-demand, instant storage capacity allocation

VJBOD is the QNAP implementation of software-defined storage and brings several benefits and practicalities to small and medium-sized business storage architecture. Software-defined storage enables a high degree flexibility and expand-on-demand capability. Use QNAP Virtual JBOD (VJBOD) to instantly allocate the storage space from another QNAP NAS as an iSCSI LUN. Use the iSCSI LUN to create storage pools, take snapshots, make a clone from snapshots or index multimedia files into the media library on the local NAS.

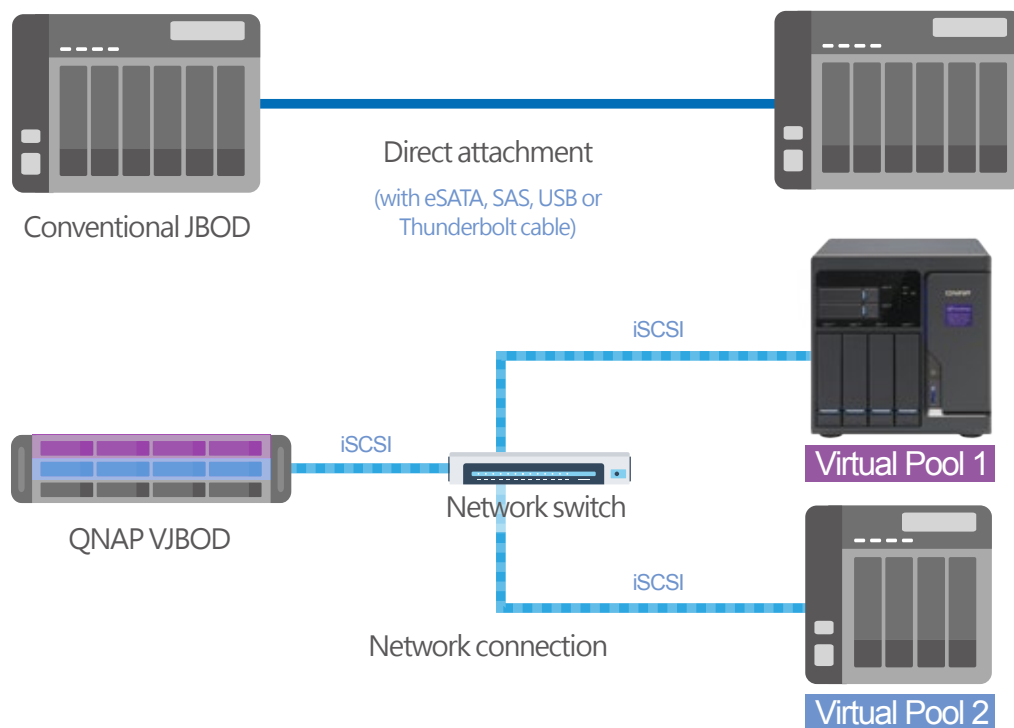

With the networked and virtual expansion units, online capacity expansion with all available space among multiple QNAP NAS is made possible in lieu of attaching a physical expansion unit. This also helps maximizing the utilization of storage resources.

Remotely expand storage capacity

Enable the native iSCSI service and storage pool creation to allocate the capacity on it as Virtual JBOD. For example, a TVS-882 daisy-chained with six TX-800P expansion units can have approximately 432TB raw storage capacity in total (calculated using 8TB HDDs). Further, the capacity can be easily expanded up to 1PB using QNAP VJBOD.



* The support for iSCSI service and storage pool is required for the remote QNAP NAS. The maximum number of NAS for VJBOD configuration is 8
 ** QNAP VJBOD is only supported on the following models: X89, X82, X80, X79, X71, X70, X63, X53, IS-400. QTS firmware 422 or later is required.

Intuitive and easy-to-use interface

It does not take complicated commands or procedures to set up Virtual JBOD. First you need two connected QNAP NAS. Then click “Virtual JBOD” in the Storage Manager in QTS. Then follow the “Create Virtual Disk” wizard to search for the remote NAS, check the available capacity, and add the space as a virtual disk on your local drive. Then you can freely utilize and manage this virtual disk in Storage Manager, including checking the status and network location of this virtual disk*. This saves time from having to log in to a remote NAS.

 *The Q-center app offers convenient tools for you to monitor the status of remote NAS.



Step 1: Click "Virtual JBOD" in Storage Manager.



Step 2: Search for the remote NAS.



Step 3: Check the available space and create a virtual disk.

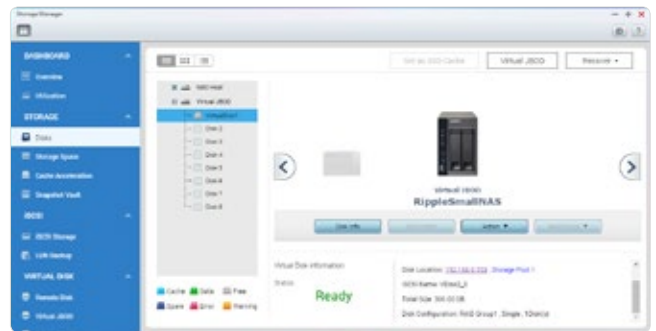

Step 4: The storage space is added as a virtual disk on your local drive.

Building high-performance VJBOD storage with super-high-speed 40GbE networking

VJBOD offers greater flexibility with online capacity expansion over traditional JBOD expansion. Build a high-performance VJBOD SAN with high-speed 40GbE networking based on the highly converged integration of hardware and software technologies from QNAP. For data centers that demand high transmission, full support for 10GbE or 40GbE network adapters and switches drive data transmission performance to be close to that of local disk. Furthermore, you can receive extra performance benefits by deploying Windows Offloaded Data Transfer (ODX) in Windows Server 2012 (or Windows Server 2012 R2, Windows Server 2012, Windows 81, Windows 8) to directly transfer data between virtual disks within or between compatible JBOD expansion units, bypassing the host computer.

 *The NAS apps do not support Offloaded Data Transfer (ODX).

	VJBOD	JBOD
Connection Interface	Ethernet (1GbE, 10GbE, or 40GbE)	USB 3.0, SAS 6G/12G
Max. Number of Connected Devices	8 virtual disks (multiple disks can be added from the same remote NAS)	Depends on the NAS model (1~8 expansion units)
Connection Method	Network	Single connection or daisy-chained
Connection Redundancy	Supports port trunking	Not supported
Application Scenario	Multiple QNAP NAS units offering the flexibility in storage utilization while maintaining the highest availability	It can be used to expand local storage pools on a single QNAP NAS unit.

Redundant network architecture to increase reliability of VJBOD

Online capacity expansion over the network does not cause an associated instability of storage space utilization. QNAP NAS equipped with two or more Ethernet ports supports port trunking (link aggregation with multiple LAN ports). Compared with single-LAN transmission, port trunking increases the bandwidth of your NAS and provides fail-safe traffic to maintain network connectivity in the case of a connection failure. Furthermore, with port trunking, network traffic will automatically achieve load balancing for each connected device.

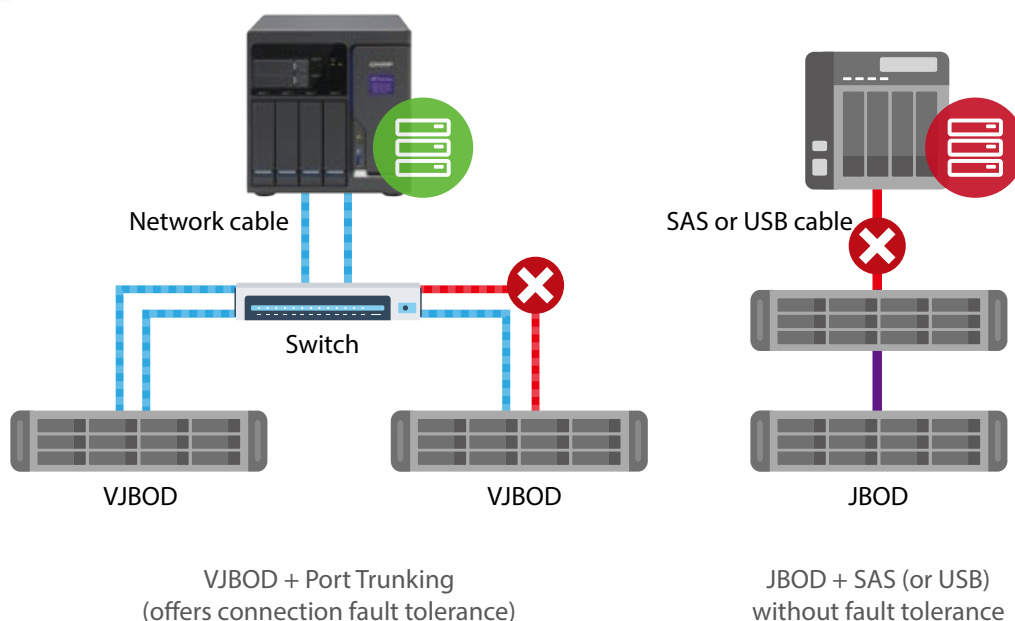

Automatic VJBOD storage recovery after auto-reconnection

In addition to Missing mode protection of locally attached JBOD expansions, VJBOD employs an advanced mechanism for disconnection prevention. If the remote NAS experiences a power outage, disconnection, or change in IP address, you will get warnings via event notifications in QTS. Further, the NAS will automatically try to reconnect and recover the VJBOD storage without user intervention.

All	Error	Warning	Success																								
1	0	0	13																								
<table border="1"> <thead> <tr> <th>Event</th> <th>Time</th> <th>Message</th> <th>Severity</th> </tr> </thead> <tbody> <tr> <td>Disk Detected</td> <td>2015/03/24 16:54:08</td> <td>Virtual JBOD Disk 1 has been detected</td> <td>Success</td> </tr> <tr> <td>Enclosure Report</td> <td>2015/02/24 19:39:10</td> <td>Virtual JBOD has been ejected</td> <td>Warning</td> </tr> <tr> <td>Power Off</td> <td>2015/03/24 16:55:07</td> <td>Power Off R/W Cache 2 is inactive</td> <td>Warning</td> </tr> <tr> <td>Virtual JBOD Target</td> <td>2015/02/24 19:32:59</td> <td>Virtual JBOD Target 'ion2004-04.com.qnap-208' size 10485761937 is disconnected</td> <td>Warning</td> </tr> <tr> <td>Disk Detected</td> <td>2015/03/24 16:18:17</td> <td>Virtual JBOD Disk 2 has been detected</td> <td>Success</td> </tr> </tbody> </table>				Event	Time	Message	Severity	Disk Detected	2015/03/24 16:54:08	Virtual JBOD Disk 1 has been detected	Success	Enclosure Report	2015/02/24 19:39:10	Virtual JBOD has been ejected	Warning	Power Off	2015/03/24 16:55:07	Power Off R/W Cache 2 is inactive	Warning	Virtual JBOD Target	2015/02/24 19:32:59	Virtual JBOD Target 'ion2004-04.com.qnap-208' size 10485761937 is disconnected	Warning	Disk Detected	2015/03/24 16:18:17	Virtual JBOD Disk 2 has been detected	Success
Event	Time	Message	Severity																								
Disk Detected	2015/03/24 16:54:08	Virtual JBOD Disk 1 has been detected	Success																								
Enclosure Report	2015/02/24 19:39:10	Virtual JBOD has been ejected	Warning																								
Power Off	2015/03/24 16:55:07	Power Off R/W Cache 2 is inactive	Warning																								
Virtual JBOD Target	2015/02/24 19:32:59	Virtual JBOD Target 'ion2004-04.com.qnap-208' size 10485761937 is disconnected	Warning																								
Disk Detected	2015/03/24 16:18:17	Virtual JBOD Disk 2 has been detected	Success																								
View Log <input type="button" value="Clear All"/>																											

Instant migration of VJBOD without physical plug and unplug

Typically, to migrate an expansion unit, you would need to manually plug and unplug the device and transport it to the destination. However, with the VJBOD that can be connected using iSCSI and safely detached as a storage pool in Storage Manager, virtual disks that have been detached from your NAS can be used again on other NAS. Thus, the data and application on the virtual disks can be accessed on other NAS and shared among different QNAP NAS devices.

*For virtual disks that have been connected via iSCSI targets to be used in Virtual JBOD, they should be excluded from other iSCSI initiator connections.

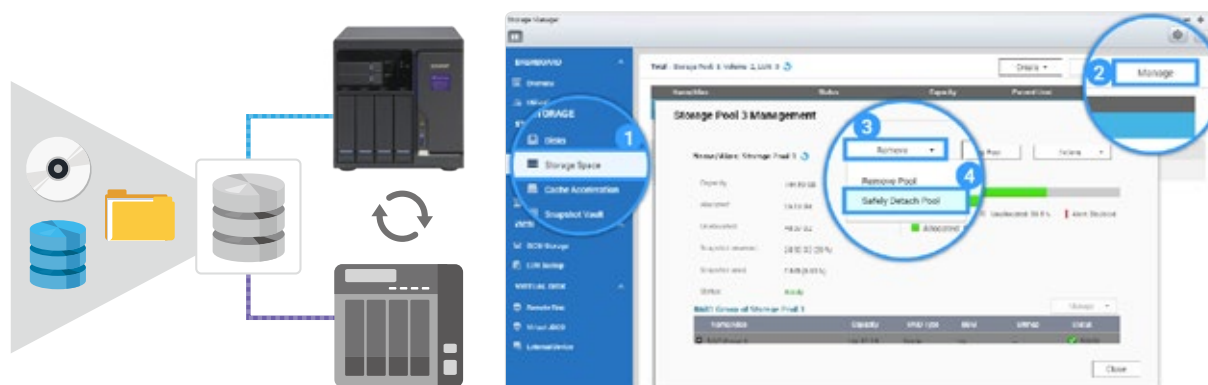

QNAP NAS Virtualization



Virtualization Station

Enhanced Software Defined Network architecture for dramatic efficiency improvements

Virtualization Station eliminates the constraints that exist on conventional VMs (e.g. slow network speeds and VM backup difficulties) to provide the best user experiences. Create multiple VMs on a QNAP NAS and install Windows®, Linux®, Android™, and UNIX® based VMs so that every VM can serve in a different role. One QNAP NAS can literally be every type of computer you need.

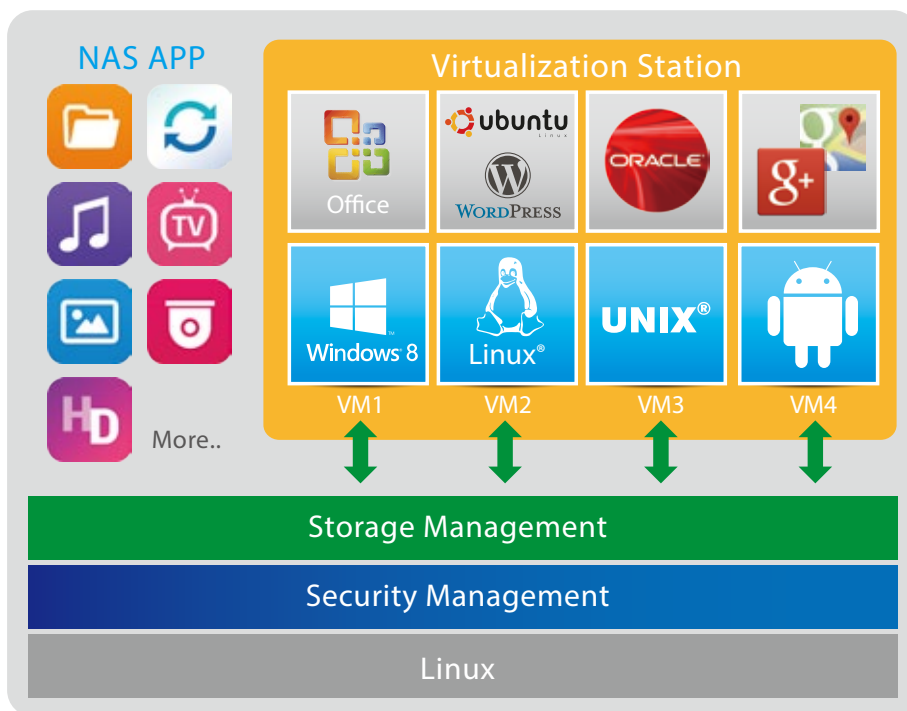

QNAP advances in VM network structure, again — the Software Defined Network

A dedicated 10 GbE LAN port for VM Ethernet is no longer needed. By adopting a Software Defined Networking approach, VMs can now share the network interface with the QNAP NAS to maintain the best data transmission speed without being limited by hardware resources.

Previously, virtual machines required dedicated network ports.

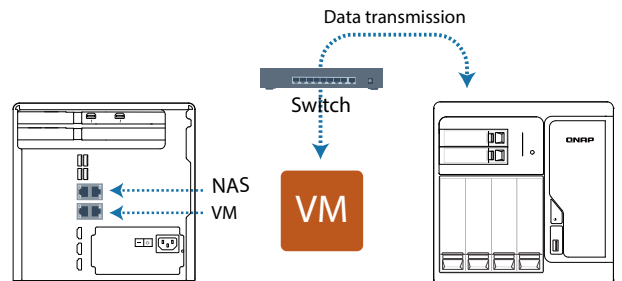

Now, virtual machines can share network ports with the NAS.

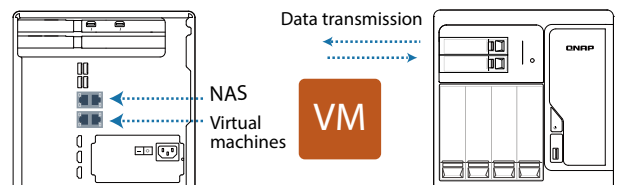

VM orchestrator manages workload schedules through communication with the Hypervisor at the Application Layer.

When the Virtualization Station orchestrator receives a transmission request from the Hypervisor, the orchestrator will signal the vSwitch Controller (as the QNAP NAS's network control), and then the vSwitch Controller of the control layer will dynamically adjust the Hi-speed Virtual Switch so that VMs can connect with the Physical Networks or NAS storage for data communication.

By employing a high-performance virtual switch VMs are no longer confined to the limits of the transmission speed of the physical NICs when transmitting data between VMs or between VMs and the NAS. This additionally frees up 10GbE network ports for other services instead.

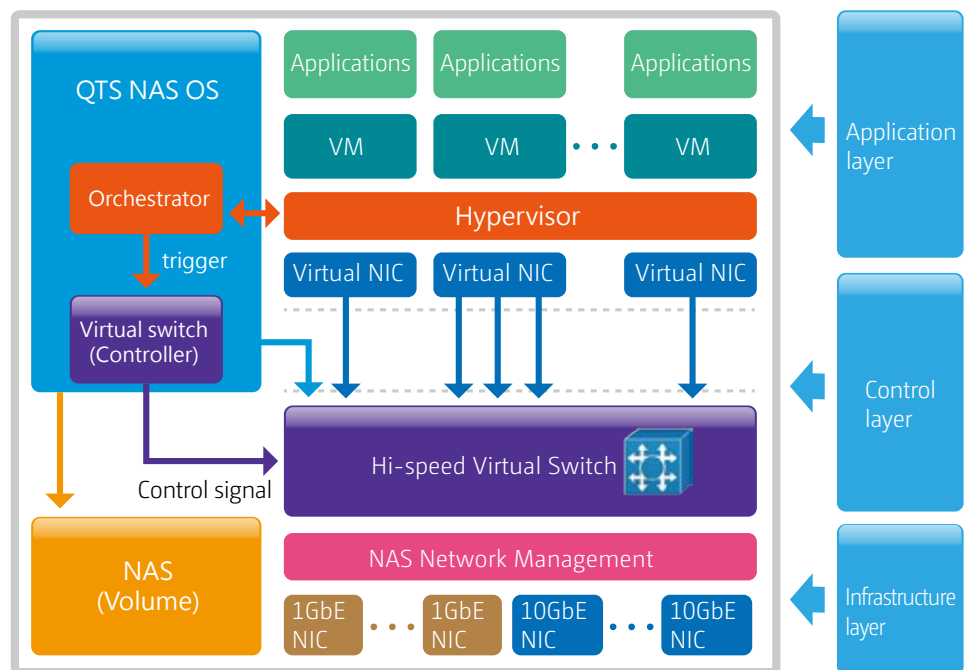

Virtual Switch

Virtual Switch is the new network architecture employed by Virtual Station. Virtual Switches are an efficient and effective network design when compared to dedicated network ports. Virtual Switches enable VMs' to share Ethernet interfaces removing the need for a dedicated VM network. Bypassing the need to transfer data through the physical network equipment also boosts the transfer rate between VMs and the NAS. The Virtual Switch is capable of 10 GbE and port-trunking, enabling you to obtain a fast and secure network environment.

Different networking modes of Virtual Switch

- Bridged networking

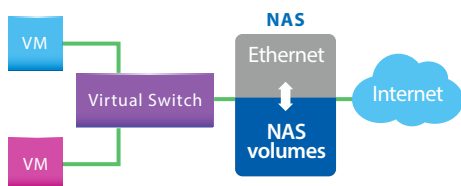

Attaching an Ethernet interface (Port-trunking available) to a Virtual Switch creates a bridged network. The NAS and the Virtual Switch can share the same Ethernet interface without occupation and supports high-speed data transfer via internal routing.

- External-only networking

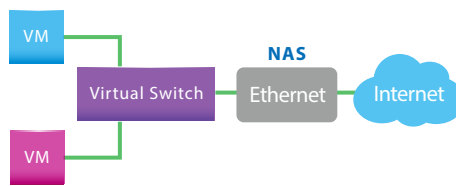

Specify an Ethernet interface for a Virtual Switch to enable dedicated routing between virtual switches and external networks. Enable DHCP to automatically assign an IP address to a Virtual Switch or choose to manually assign an IP address.

- Isolated networking

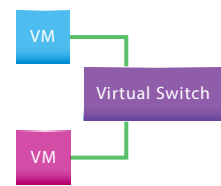

Not attaching any Ethernet interface to a Virtual Switch creates an isolated network. Manually setting IP address of VMs can enable communication between VMs connected to the same Virtual Switch.

* Available port-trunking modes: Active Backup, IEEE 802.3ad, Balance-tlb.

QVM supports 4K displays, audio output

QVM in the HybridDesk Station enables the use of a VM as a PC simply by connecting an HDMI® monitor, keyboard, and a mouse. QVM offers 4k resolution and virtualized audio output to support a wide variety of applications. Using a browser with HTML5 is limited to 1080P without audio. This makes QVM ideal for video applications.

 noVNC is an HTML5-based remote desktop web client that can communicate with a VM. noVNC does not support audio transmission. For audio output, use Windows® Remote Desktop or the SPICE® Client to connect to the VMs. For more information about SPICE® Client, please visit "Tutorials and FAQ" of the QNAP website.



VM backup and restore

Virtualization Station makes managing multiple virtual machines on a QNAP NAS effortless. Virtual Machines can be backed up and restored centrally using an easy-to-use interface. Users can obtain scheduled tasks/status, and manually start or stop backup tasks. The online backup tasks run in the background without interrupting VM operations and/or powering off the system. Furthermore, you can set the schedule for backup tasks and maximum number of backup copies. When restoring, the system will automatically start up the restored VM, simplifying the whole process and reducing system downtime.

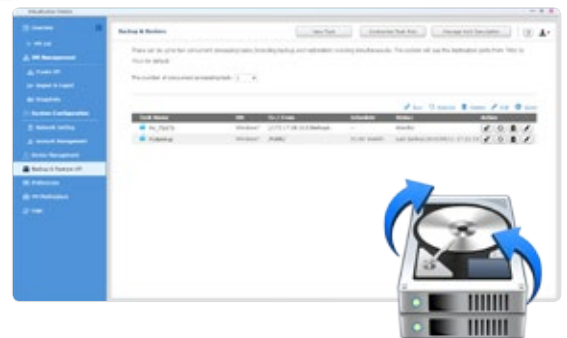

Device Management

The Device Management screen provides an overview of all VMs, keeping you informed of the storage capacity, network interface, and USB devices of the NAS as well as letting you connect or remove a new device without shutting down the VMs.

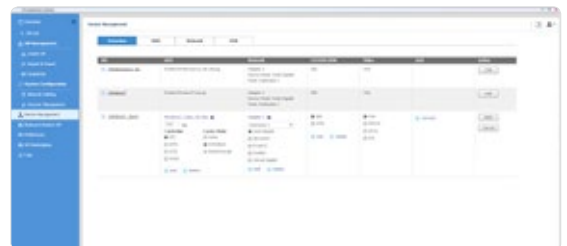

Remote connection with virtual desktop

Enjoy the convenience of operating Windows®, Linux®, UNIX®, and Android™ based VMs as remote desktops with a common browser such as Google® Chrome, Firefox®, etc. A list of buttons is provided on each individual VM display, allowing users to suspend, shutdown, force shutdown, reset, bring up key combinations: Ctrl+Alt+ Del and function keys, and take snapshots of the VMs.

The Virtualization Station supports SPICE and VNC connections. Connect to the VMs on the NAS with the SPICE (virt-viewer) or VNC client software. Windows Remote Desktop is also supported.



USB devices (USB Pass-through) (USB Passthrough)

Virtualization Station supports connecting USB devices to virtual machines. Commonly used USB devices such as storage devices and card readers can be connected to virtual machines, and you can select a specific device using Virtualization Station. This can be used together with QVM Desk just like a PC. You can also connect USB card readers/scanners to a QNAP NAS via Virtualization Station and store scanned data directly to the NAS without taking up Internet bandwidth. Further, with the advent of USB 3.0, higher data transmission can be easily achieved.

 * Please note that this function is only available on Windows® 8, Windows® 8.1 and later versions.

Seven advantages of QNAP's exclusive virtualization technology



Visibility and direct access to files

Specific file formats cannot be opened directly by the QNAP NAS, but the Virtualization Station makes it possible. This saves bandwidth and access time. Administrators can install Windows®, Linux®, UNIX®, and Android™ based VMs on the QNAP NAS to run any supported application or file.

Save bandwidth & time

Downloading a large amount of data to a local PC can take a long time and use up network bandwidth. When accessing data on the QNAP NAS through virtual machines on the Virtualization Station, you can enjoy secure data transmission and save bandwidth & time as the data is not transmitted via physical network cables.

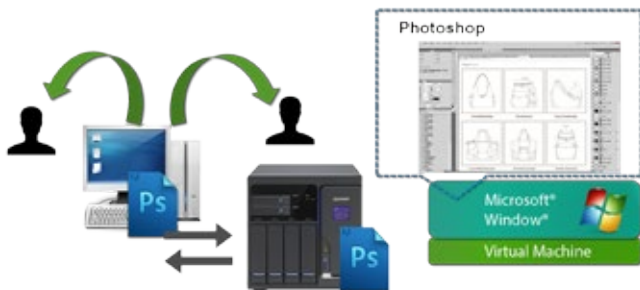

Enhanced security

When accessing files & data on a virtual machine they are not transmitted outside of the QNAP NAS. This provides a secure environment that prevents sensitive data from being intercepted and saves bandwidth and network resources when accessing large files.

User-based permissions settings

The Virtualization Station administrator can create users and set granular permissions for each Virtual Machine (VM), helping to efficiently manage and allocate VM resources for users with different needs. With these permissions, users can work independently on their VM without worrying about their work being interrupted or data being lost because another user has accidentally powered-off the VM.

- User-based permissions include:
 - Console permissions: Control and View-only
 - VM controls: Snapshot and Advanced

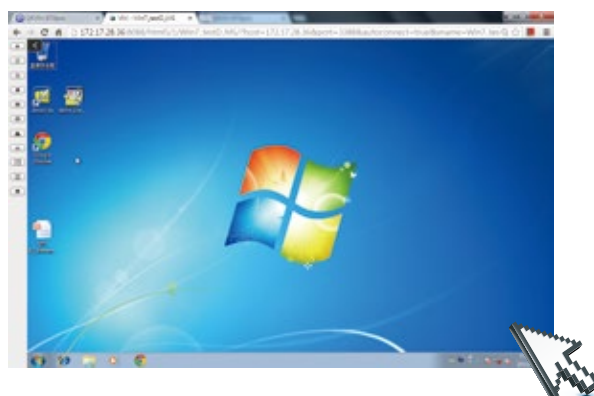
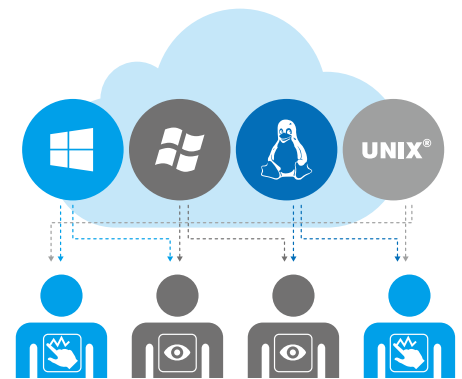

Operate VMs as Remote Desktops

Enjoy the convenience of operating Windows®, Linux®, UNIX®, and Android™ based VMs as remote desktops. A list of buttons is provided on the left side of each individual VM display, allowing users to suspend, shutdown, force shutdown, reset, bring up key combinations: Ctrl +Alt+ Del and function keys, and take snapshots of the VMs.

GPU Pass-through for a multitude of applications

A Graphics Processing Unit (GPU) is a single processor with a massively parallel architecture of thousands of smaller cores making them ideal for handling multiple tasks simultaneously. GPUs are used in highly-sophisticated engineering applications. And with OpenCL (Open Computing Language) and Microsoft® DirectX 11 Compute Shader, it can be utilized in accelerating applications for general tasks that require high performance parallel computing such as transcoding and 3D animation & video rendering.

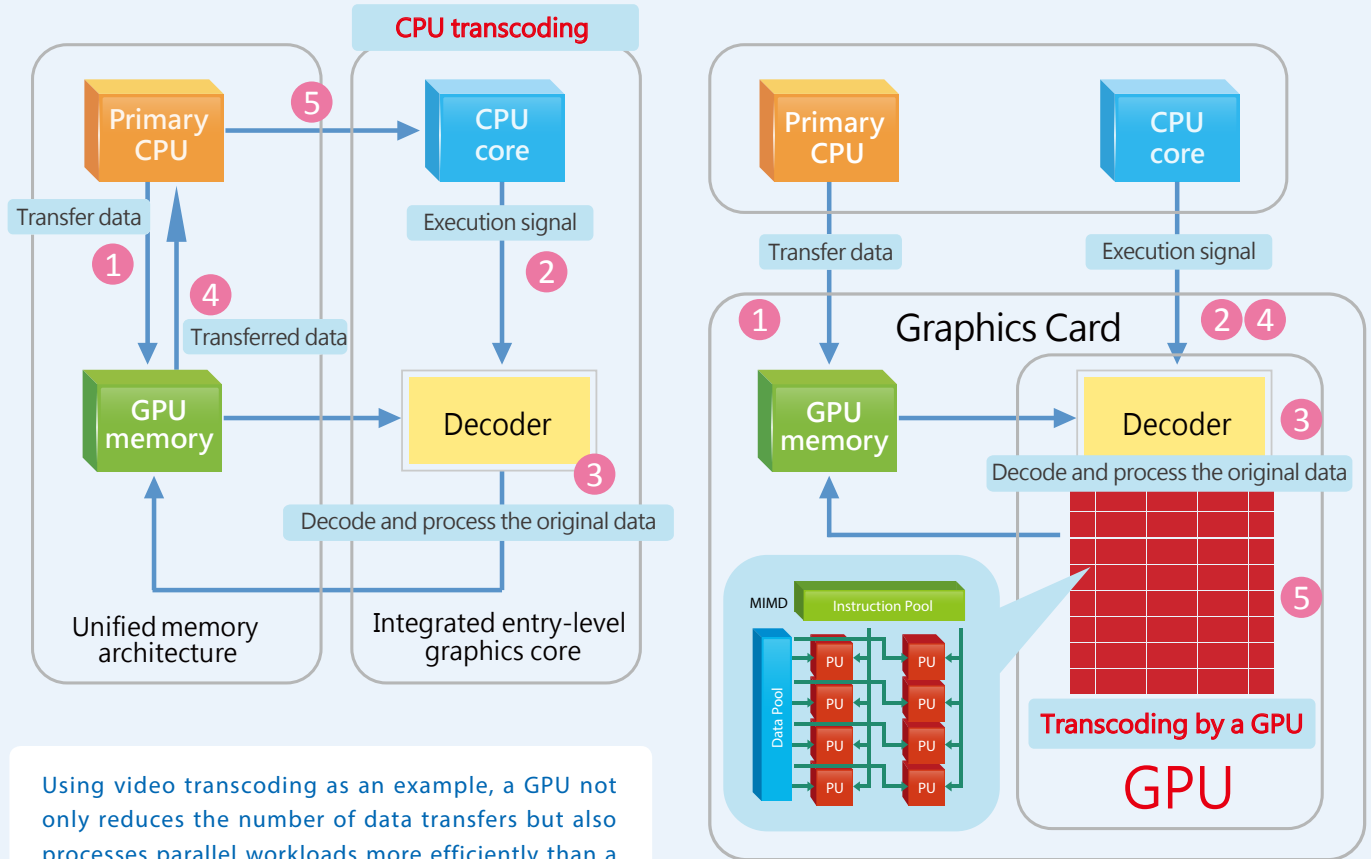

Using video transcoding as an example, a GPU not only reduces the number of data transfers but also processes parallel workloads more efficiently than a CPU.

The use of GPU in virtualization has many challenges. There are no standardized modes of operation in virtualized platforms among GPUs. To fully leverage a GPU's application-accelerating capabilities, the TVS-x82 uses a Pass-Through mode to dedicate one GPU to a single virtual machine and other GPUs to other virtual machines. One virtual machine can be dedicated to exclusively run GPU computation, lifting the burden from the CPU for other jobs while significantly improving overall system performance.

TVS-x82, TVS-ECx80U-SAS, and TS-ECx80U models support GPU pass-through with AMD Radeon™ R7 and R9 series GPUs. (Please check the external power supply requirements, and physical dimensions when selecting graphics cards to be installed on the NAS.)

450W models of the TVS-x82 series

High-performance graphics cards provide superior graphics rendering and floating-point computation at the cost of higher power requirements. To accommodate these graphics cards, the TVS-882 and TVS-1282 are equipped with 450W power supplies to provide adequate power.



TVS-882-i5-16G-450W



TVS-1282-i5-16G-450W
TVS-1282-i7-32G-450W



Container Station

Rapid Deployment of Container-based Applications

Virtualization is key to maximizing IT resource utilization in the era of big data and IoT (Internet of Things). Container Station is developed following the Just enough OS, or JeOS, philosophy. This lightweight virtualization technology can instantly and truly create a ready-to-use environment on PCs, QNAP NAS and the Cloud for RD developers and IT administrators.

For example, build a project in Container Station on your home computer and after the completion of each stage of the development, upload the container to Docker Hub™ or export and save it on the NAS. Your coworkers can then download the container and continue with the next development stage. With a container-based application, on QNAP NAS, virtualized servers, OpenStack, or on the cloud, developers can deploy and share any app on any of these platforms, quickly and reliably.



A growing number of popular apps

Container Station offers the most up-to-date and top-of-technology applications for rapid deployment with just a click. The following apps are now available: LibreOffice, MongoDB, Nginx, Node.js, Redis, MySQL, WordPress, Deluge, Minecraft, Wine, Jenkins, GitLab, Redmine, Joomla! and OpenERP.



Container Station is available in the App Center.

Docker and the Docker logo are trademarks or registered trademarks of Docker, Inc. in the United States and/or other countries. Docker, Inc. and other parties may also have trademark rights in other terms used herein. Linux® is the registered trademark of Linus Torvalds in the U.S. and other countries.

Integrate LXC and Docker® to bring even more value to your NAS

LXC: the lightweight Linux Container enables a high-performance lightweight virtualized Linux® environment on your NAS. Install a lightweight version of Linux® (e.g. Ubuntu, Debian, Fedora) as the base for your containerized application with LXC.

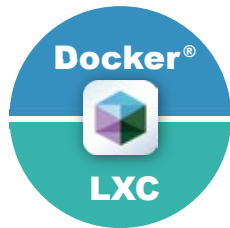

Install-on-demand applications

Use the Docker Hub™ to search for publicly shared applications, whether they are databases, web servers, programming languages, or development tools; install it as you would an app on your smartphone.

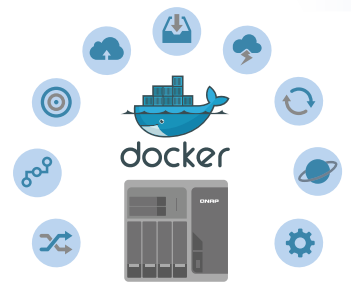

One-click installation

Forget complicated configuration and simply enjoy the benefits of software containers. Just click "Create" and the system will automatically download and install the applications.

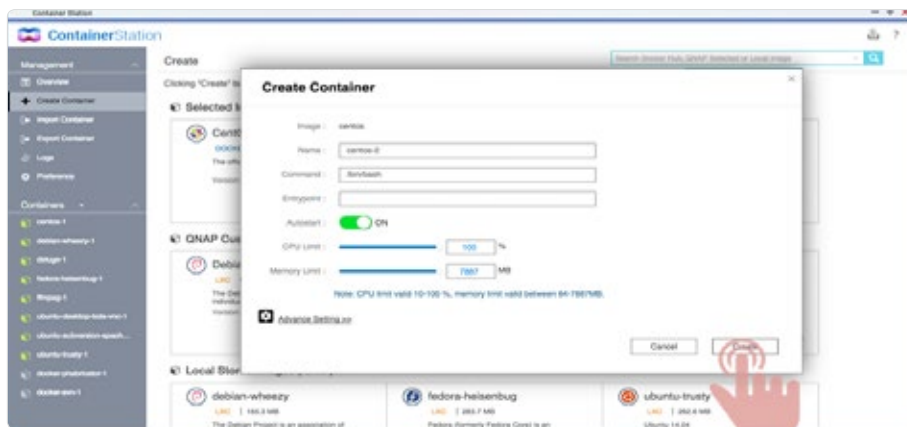

Containers on ARM-based NAS

Entry-level NAS models, e.g., TS-231+, TS-431+ can enable Linux® virtualization on QTS 4.2.1. Just download the default Linux® version from Container Station and you can have the only virtualization-ready with LXC and Docker® on the ARM® based NAS.

Access shared folders

Shared folders mounted in a container (or from other containers) save data to the NAS at comparable access speeds to that of bare metal environment.

Export/import software containers

You can export software containers along with data contained in it to a given shared folder. You can also import software containers from a PC or shared folders. Containers can also be easily backed up and transferred to other QNAP NAS units.



Resource management

Specify host CPU/memory resources allocated to a software container and monitor the host in addition to each container's performance from a single screen. The visualized presentation with graphics provides a quick overview of resource consumption and aids in resource management.



Online Document - Online document preview and editing

The increasing risks of breaches and leaks mean both business and personal data needs greater protection against unauthorized access.

With a traditional NAS, you must download files from the NAS to your computer, open and edit them, and then upload them to the NAS again.

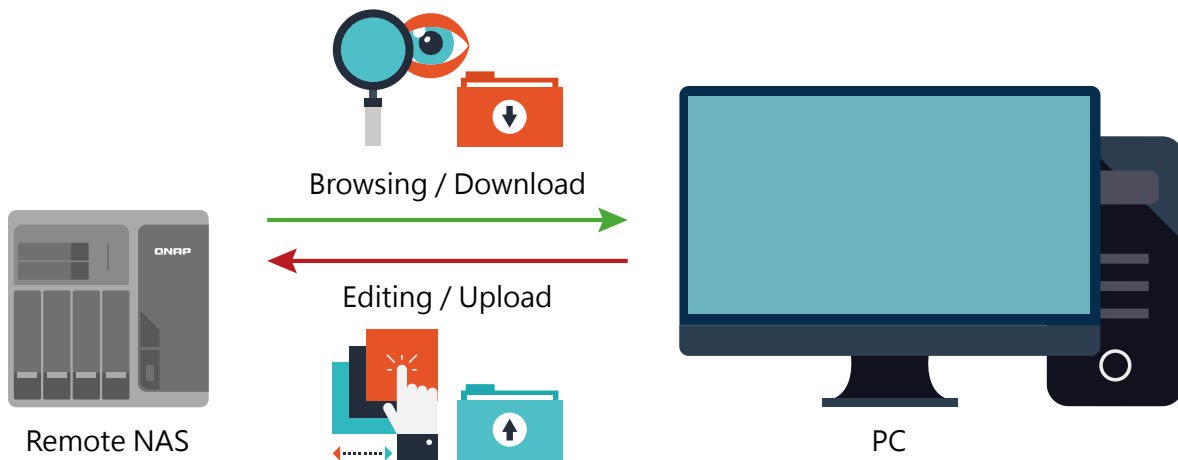

With Container Station's Online Document function, you can directly preview, edit, and save (Office documents, photos, and text files) files on the NAS from anywhere.

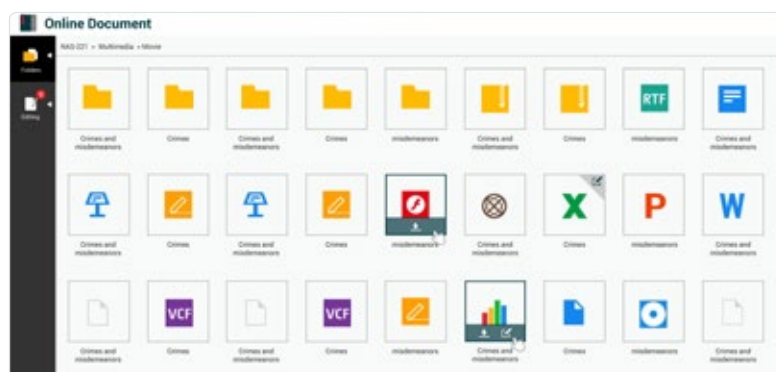

Supports a wide range of file types used by LibreOffice®, Pinta, Emacs, and more.

LibreOffice®- a powerful office suite

The suit has many applications: Writer (word processor), Calc (spreadsheet application), Impress (presentation engine), Draw (drawing and flowcharting application), Base (database and database frontend), and Math for editing mathematics.

Pinta - a program for drawing and image editing

It offers a simple yet powerful way to draw images with file formats such as JPEG/JPG, Tiff, TGA, PNG, ICO, BMP and OpenRaster. It is surely more powerful than Windows Paint.

Emacs – a customizable text editor

Emacs is a powerful text editor with extensibility and customizability. It is popular among programmers and computer technicians.

☰ Container Station 1.4 or later (available Q1 2016) is supported.

The emergence of DevOps ("Development Operations") – Utilize Container Station to establish a continuously integrated development environment

No need to memorize complicated software configurations, just install the necessary apps on demand with one click and the system will automatically finish the set-up process, quickly facilitating a development environment suited for collaboration.

A continuously integrated development environment

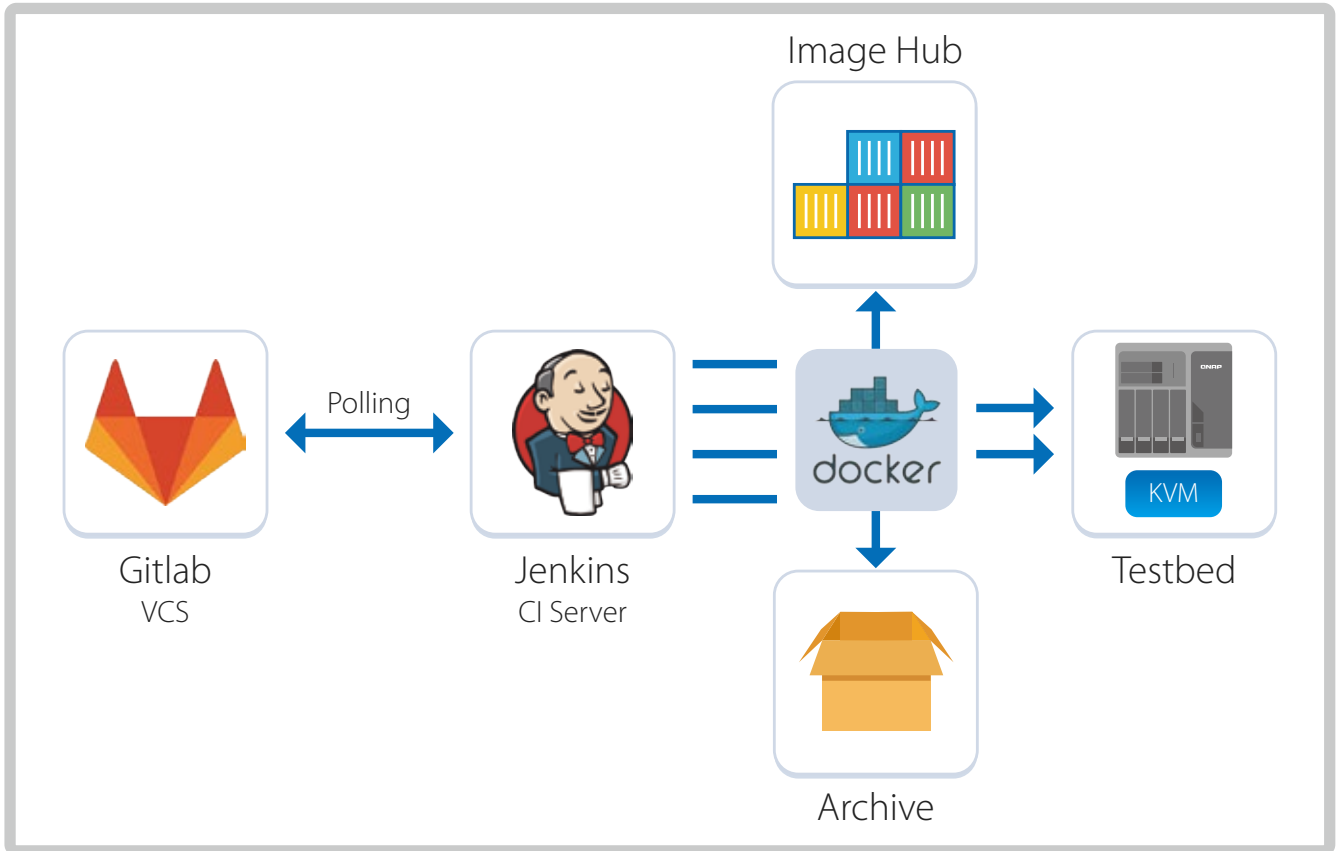

☰ Recommended apps for quick installation: Private Registry, GitLab, Jenkins.

Hardware Specifications



NAS Model	TVS-682		TVS-882		TVS-1282		
Ordering SKU	TVS-682-PT-8G	TVS-682-i3-8G	TVS-882-i3-8G	TVS-882-i5-16G TVS-882-i5-16G-450W	TVS-1282-i3-8G	TVS-1282-i5-16G TVS-1282-i5-16G-450W	TVS-1282-i7-32G TVS-1282-i7-32G-450W
CPU	Intel® Pentium® G4400 3.3 GHz dual-core processor	Intel® Core™ i3-6100 3.7 GHz dual-core processor	Intel® Core™ i3-6100 3.7 GHz dual-core processor	Intel® Core™ i5-6500 3.6 GHz quad-core processor	Intel® Core™ i3-6100 3.7 GHz dual-core processor	Intel® Core™ i5-6500 3.6 GHz quad-core processor	Intel® Core™ i7-6700 3.4 GHz quad-core processor
Memory	Total DIMM slots: 4 Maximum memory: 32 GB (8 GB x4) Memory modules pre-installed: 8 GB DDR4 RAM (4 GB x 2) <i>Note: The pre-installed memory modules need to be replaced when expanding the memory to over 24 GB.</i>		Total DIMM slots: 4 Maximum memory: 32 GB (8 GB x4) Memory modules pre-installed: 8 GB DDR4 RAM (4 GB x 2)		Total DIMM slots: 4 Maximum memory: 32 GB (8 GB x4) Memory modules pre-installed: 8 GB DDR4 RAM (4 GB x 2)		
			Memory modules pre-installed: 16 GB DDR4 RAM (8 GB x 2)	Memory modules pre-installed: 16 GB DDR4 RAM (8 GB x 2)	Memory modules pre-installed: 16 GB DDR4 RAM (8 GB x 2)	Memory modules pre-installed: 16 GB DDR4 RAM (8 GB x 2)	Memory modules pre-installed: 32 GB DDR4 RAM (8 GB x 4)
Flash Memory	512MB DOM						
M.2 Slot	2 x M.2 2242/2260/2280/22110 SATA 6Gb/s SSD <i>Note: The M.2 SSD is not included in the product package.</i>						
Drive Tray	2 x 2.5" SSD 4 x 2.5"/3.5" hard drive or SSD		2 x 2.5" SSD 6 x 2.5"/3.5" hard drive or SSD		4 x 2.5" SSD 8 x 2.5"/3.5" hard drive or SSD		
Drive Interface	SATA 6Gbps/3Gbps						
USB	Front: 1 x USB 3.0 port / Back: 4 x USB 3.0 port						
Ethernet	4 x GbE port						
Video Output	3 (HDMI 1.4b x2, HDMI 2.0 x1)						
Audio Input	2 x 6.3mm microphone jack						
Audio Output	2 x built-in speaker, 1 x 3.5mm Line-out jack <i>Note: Only one of the above audio output ports can work at a time. If a speaker is connected, the sound will output through the speaker.</i>						
LED Indicators	System status, 2.5" SSD, M.2 SSD, 3.5" HDD/SSD						
Buttons	Power, USB One-touch-copy backup, Reset						
System warning	Buzzer						
Form Factor	Tower						
Dimensions	231.9 x 224.9 x 319.8 mm		231.9 x 292.8 x 319.8 mm		234.6 x 369.9 x 319.8 mm		
Weight	Net (NAS only): 7.7 kg/16.96 lb Gross (with the package and accessories): 9.5 kg/ 20.94 lb		Net (NAS only): 9.05 kg/19.95 lb Gross (with the package and accessories): 10.85 kg/ 23.92 lb		Net (NAS only): 11.55kg/25.46 lb Gross (with the package and accessories): 13.65 kg/ 30.09 lb		
Sound Level (dB)	Sound pressure (LpAm) (bystander position): 20.5 dB (with 4 x Seagate ST2000VN000-1HJ164 HDDs installed)		Sound pressure (LpAm) (bystander position): 21.8 dB (with 6 x Seagate ST2000VN000-1HJ164 HDDs installed)		Sound pressure (LpAm) (bystander position): 21.6 dB (with 8 x Seagate ST2000VN000-1HJ164 HDDs installed)		
Temperature	0-40°C						
Relative Humidity	5~95% non-condensing, wet bulb: 27°C						
Power Supply	Input: 100-240V~, 3-1.5A, 60-50Hz; Output: 250W		TVS-882-i3-8G / TVS-882-i5-16: Input: 100-240V~, 3-1.5A, 60-50Hz; Output: 250W TVS-882-i5-16G-450W: Input: 100-240V~, 8-4A, 60-50Hz; Output: 450W		TVS-1282-i3-8G / TVS-1282-i5-16G/TVS-1282-i7-32G: Input: 100-240V~, 3-1.5A, 60-50Hz; Output 250W TVS-1282-i5-16G-450W / TVS-1282-i7-32G-450W: Input: 100-240V~, 8-4A, 60-50Hz; Output: 450W		
PCIe Expansion Slot	2 (1* PCIe Gen3 x16; 1* PCIe Gen3 x4)				3 (1* PCIe Gen3 x8; 2* PCIe Gen3 x4)		
Fan	System: 1 x 8 cm quiet cooling fan CPU: 1 x 9cm fan		System: 2 x 8 cm quiet cooling fan CPU: 1 x 9cm fan		System: 3 x 8 cm quiet cooling fan CPU: 1 x 9cm fan		

* All specifications are subject to change without notice.

For more information, please go to www.qnap.com

TVS-x82

6/8/12-bay Turbo vNAS Series

24/7 Acceleration Made Possible

With QNAP Qtier™ and SSD Cache Technologies



TVS-1282-i3-8G
TVS-1282-i5-16G
TVS-1282-i7-32G
TVS-1282-i5-16G-450W
TVS-1282-i7-32G-450W



TVS-882-i3-8G
TVS-882-i5-16G
TVS-882-i5-16G-450W



TVS-682-PT-8G
TVS-682-i3-8G

- 1 6th generation Intel® Pentium® or Core™ i3/i5/i7 multi-core processor provides up to 20% performance improvement
- 2 8GB (up to 32GB) DDR4 2133MHz RAM
- 3 USB 3.1 (10Gbps) Type-C expansion
- 4 40GbE and 10GbE network interfaces for high-speed sharing
- 5 M.2 SATA 6Gbps and SSD slots with support for PCIe NVMe SSD

QNAP Systems, Inc.

TEL : +886-2-2641-2000 FAX : +886-2-2641-0555 Email: qnapsales@qnap.com
Address : 3F, No.22, Zhongxing Rd., Xizhi Dist., New Taipei City, 221, Taiwan

QNAP may make changes to specification and product descriptions at any time, without notice.
Copyright © 2016 QNAP Systems, Inc. All rights reserved. QNAP® and other names of QNAP Products are proprietary marks or registered trademarks of QNAP Systems, Inc. Other products and company names mentioned herein are trademarks of their respective holders.

AMD, the AMD logo, and combinations thereof are trademarks of Advanced Micro Devices, Inc.

Netherlands (Warehouse Services)

Email : nlsales@qnap.com
TEL : +31(0)107600830

Germany

Email : desales@qnap.com
TEL : +49-89-381562991

China

Email : cnsales@qnap.com.cn
TEL : +86-400-628-0079

India

Email : indiasales@qnap.com

US

Email : usasales@qnap.com
TEL : +1-909-595-2782

Thailand

Email : thsales@qnap.com
TEL : +66-2-5415988



51000-024112-RS
201605(EN)A