

QNAP

4K2K UHD

QvPC
Technology



Use your Turbo vNAS as a PC

TVS-ECx80+ Edge Cloud Turbo vNAS Series

The Best Storage Solution for Edge Cloud



3 Keys to Super Boost System Performance

Flagship model TVS-EC1080+

Intel® Quad-Core Xeon® E3-1245 v3 3.4GHz and 32GB RAM
Built-in dual-port 10GbE and 256GB mSATA modules

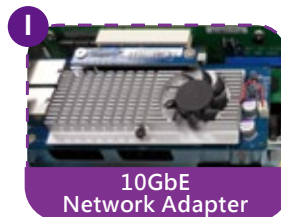

10GbE Network Adapter

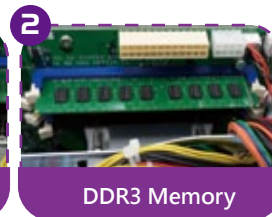

DDR3 Memory

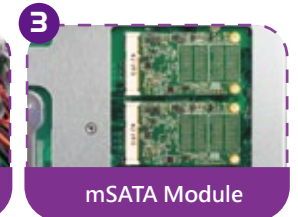

mSATA Module



TVS-ECx80+ Turbo vNAS Series



TVS-EC1080+-E3



TVS-EC1080-E3
TVS-EC1080-i3



TVS-EC880-E3

- Supports Intel® Quad-Core Xeon® E3-1245 v3 3.4GHz / Intel® Core™ i3 Dual-Core processors integrated with Intel HD Graphics P4600
- Inbuilt two 10GbE ports reaching over 2000 MB/s throughput and 223,000 IOPs
- Scale-up storage to 400 TB raw capacity
- Powered by QTS 4.1.2 with new HD Station 2.0 for 4K/2K video transcoding and playback
- Q'center centralized management system for managing multiple QNAP Turbo vNAS units
- Use the NAS as a PC with exclusive QvPC Technology
- Designed for file management, backup and disaster recovery
- NAS and iSCSI-SAN unified storage solution for server virtualization

Hybrid Enterprise Cloud Storage Architecture

With the advent of cloud computing, it is inevitable for enterprises to increase their investments in cloud services. However, enterprises are reducing IT expenses to maximize the return on investment (ROI). In addition to controlling rising costs, IT administrators must take many considerations when facilitating cloud environment. They need to incorporate new technology into existing systems without impacting the stability and performance of the system and user experience. Studies have shown that businesses opt for hybrid clouds that can integrate with an existing environment and adapt to changing business needs at the same time. In fact, more than three-quarters (76%) of IT decision makers, business users and cloud vendors expect hybrid clouds to be the core of their cloud strategies, overtaking public and private clouds in the next five years.

As enterprises migrate to cloud infrastructure for better agility and scalability, they are confronted with several challenges. Complying with high standards of evolving regulations, providing sufficient computing resources and controlling long-term operating costs are among the major challenges. This is why so many private cloud solution providers build their products with the provision of interoperability, virtualization capability, and scalability.

Interoperable solutions provided by the edge cloud devices that sit in between the public and private clouds can be leveraged to provide connectivity and data exchange capability with resources and management services running in the public cloud. As many organizations adopt the hybrid cloud storage architecture that spans on-premises enterprise storage and cloud storage services, edge cloud devices will play a key role in the deployment process. The following picture depicts that edge cloud devices help realize the communication of management and resources information with cloud services across the hybrid cloud boundary.

2015 will see a trend of deploying a hybrid cloud in businesses to optimize daily operations. We noticed a gap between high-end storage solutions designed for data centers and budget versions for the same purpose," said David Tsao, product manager of QNAP. "With the release of the TVS-ECx80+ Edge Cloud Turbo vNAS, QNAP is filling the gap with a cloud storage solution with high-standard hardware designs and an economical price.

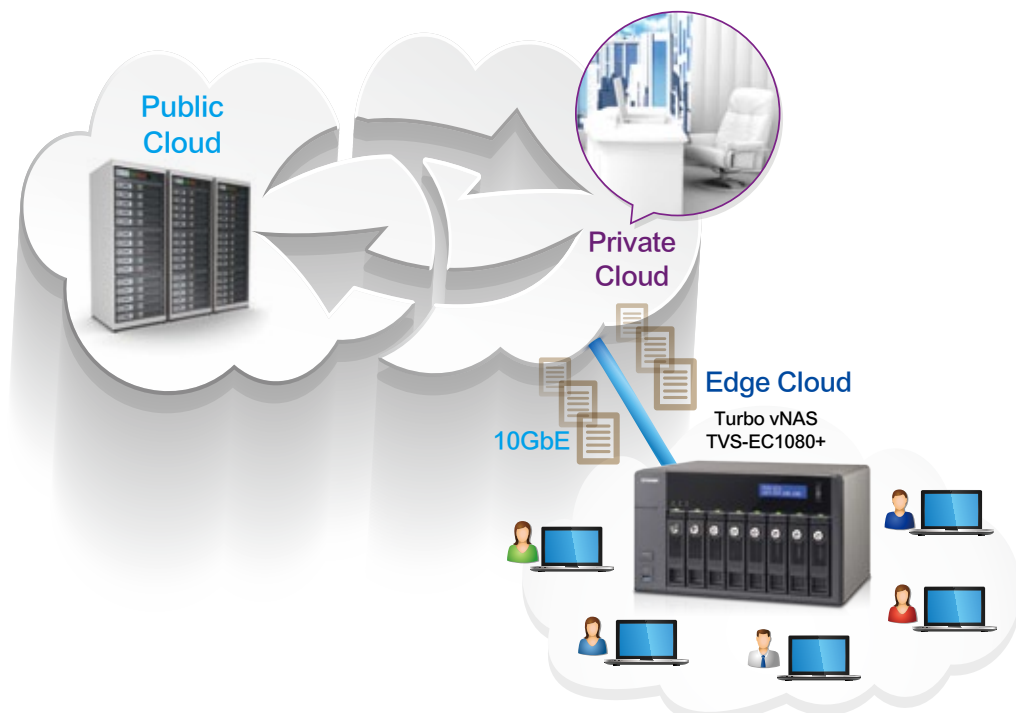

Table of Contents

Unified Storage Management	1
File Storage, Management and Sharing (File Station)	5
Q'center CMS (Central Management System)	9
Virtualization Station	11
VM Case Study	15
QvPC Technology	17
Enterprise Solutions	23
QTS 4.1.2 OS	37
Mobile Apps & Utilities	53
App Center & Development Platform	55
TVS-ECx80+ Series Hardware Introduction	59
Hardware Specifications	63
Software Specifications	64



Unified Storage Management

Unified Storage Management

QNAP's Turbo vNAS business series is an unified storage system which can serve as iSCSI SAN storage and Turbo vNAS. The powerful Storage Manager can assist you manage iSCSI LUNs and volumes efficiently.

Intelligent Storage Manager

The QTS 4.1.2 Storage Manager neatly presents tools and options for managing system storage with an intuitive graphical interface. Pools, disks and iSCSI storage, the Storage Manager provides a centralized place to easily manage different hard drives (e.g. SSD and SATA HDD) and to maximize storage usage of the tiered and unified storage.

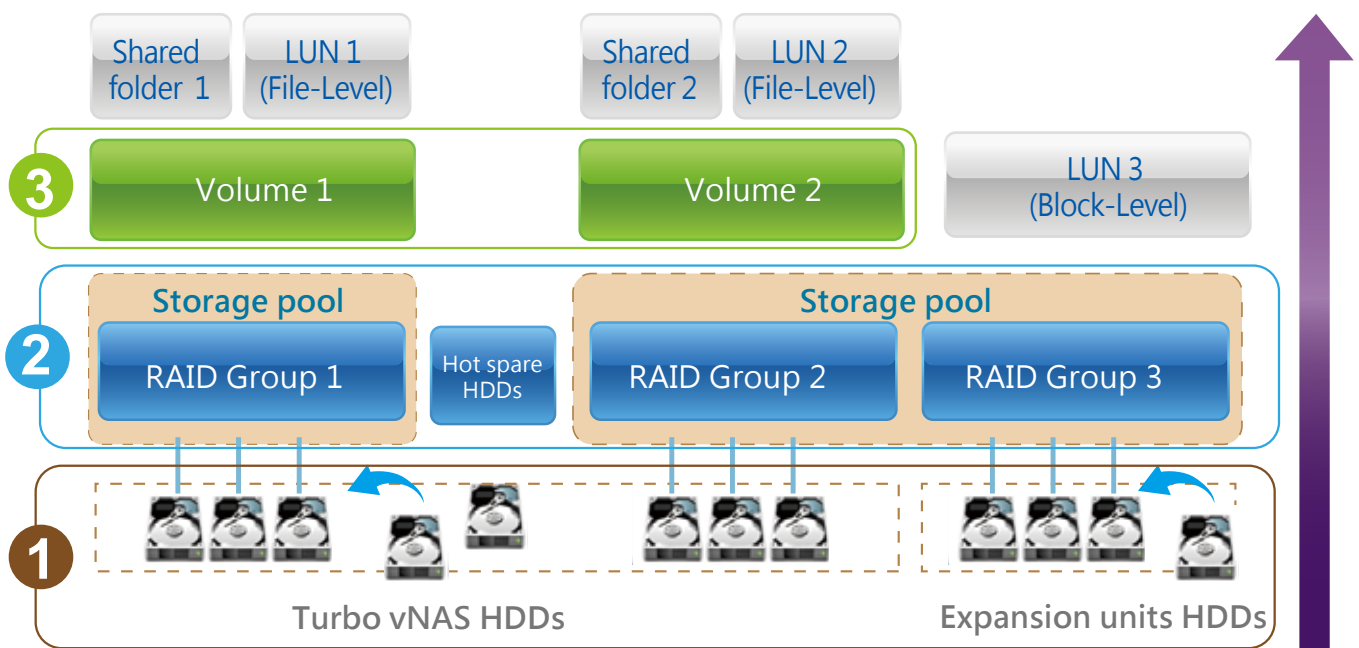

Dashboard

The Storage Manager dashboard presents an overview for IT administrators to easily check the storage allocation status. QTS 4.1.2 provides a more secure and flexible way to store and manage the NAS data. This next generation volume offers powerful features such as storage pooling with multiple RAID groups, thin provisioned volumes with space reclamation, and online capacity expansion. Just click "New Volume" and you can start to allocate capacity.



In addition to Storage Manager, IT administrators can also check the storage pool and volume status on File Station.

Shared folder	Used Size	Volume	Capacity	Free Size	Volume Status
QMap/Backup	2.13 GB	Backup	2731 GB	2731 GB	Ready
Home	84.20 KB	DataVol1	497 GB	495 GB	Ready
Public	1.91 GB	DataVol1	497 GB	495 GB	Ready
QNAP	0.00 KB	DataVol2	552 GB	552 GB	Ready

1 HDD Management

IT administrators can view the HDD information to check the HDD allocation status for RAID group. With the information, it can be ensured that there is no idle HDD for the maximized utilization of the storage resources.



2 Storage Pool

IT administrators can aggregate multiple RAID groups into a big storage pool to flexibly utilize the storage capacity as a whole, protect them using redundancy and allowing for better protection against multiple disk failures for large-capacity environments. Multiple volumes can now be created on the Storage Pool to provide flexible deployment.

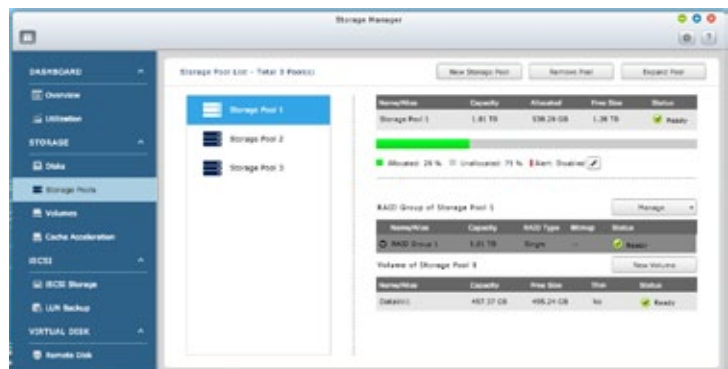

3 Flexible Volume Allocation

QTS 4.1.2 allows creating multiple volumes on the Storage Pool for various applications in typical business environments with different workgroups. Each data volume and LUN can be extended without interrupting services.

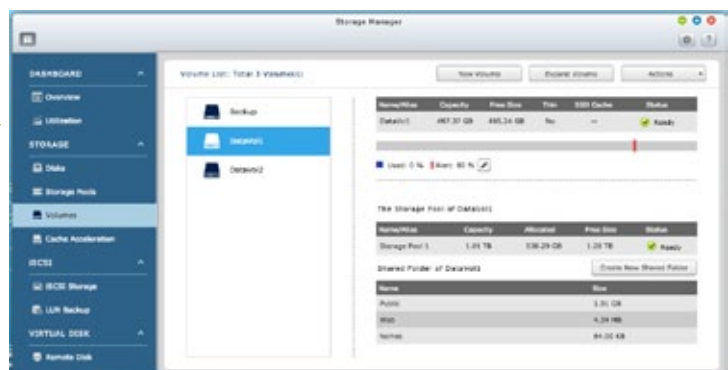

Thin provisioning

Over-allocation allows a server to view more storage capacity than has been allocated in the storage pool. Furthermore, the physical storage capacity is used only when files are written by the application, thereby improving utilization rates.

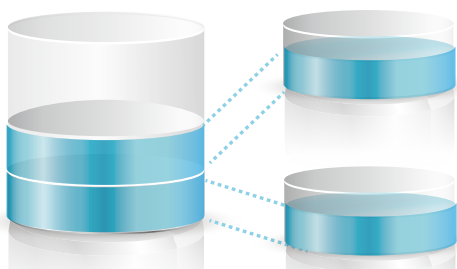

Efficiently use storage spaces with incremental allocation.

Thick provisioning

The physical storage capacity is dedicated up front when the storage volume is initially allocated.

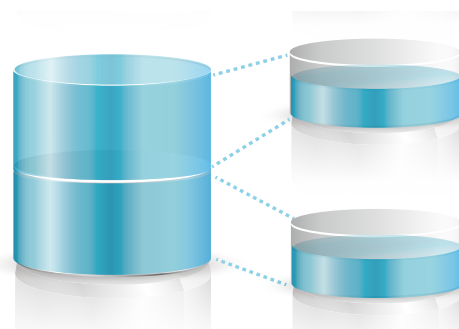

Allocate all spaces specified and they cannot be used by other volumes or LUNs.



Unified Storage Management

> iSCSI LUN

QTS 4.1.2 supports two types of LUNs for efficient storage utilization: block-level and file-level iSCSI LUNs. The Turbo vNAS also supports multiple types of configurations for server connections:

- **single LUN or multiple LUNs per iSCSI target.**
- **multiple iSCSI targets for a single LUN, only used for clustered environments**

Block-Level iSCSI LUN

Besides storing data, volumes can be utilized as an iSCSI LUN. The block-level iSCSI LUN provides less overhead which improves the overall read/write performance.

File-Level iSCSI LUN

Users can consider file-level iSCSI LUNs if there isn't enough space for block-level iSCSI LUNs. The file-level iSCSI LUN can be used for creating a disk image for an iSCSI LUN.



Both block-level and file-level iSCSI LUNs support thin provisioning, space reclamation, and online capacity expansion. We recommend using block-level iSCSI LUNs unless there is a limitation on space usage.

> Virtual Disk Drive - Increase flexibility of storage expansion

Virtual disks provide a more flexible way for IT administrators to expand storage. By using the built-in iSCSI initiator to connect an iSCSI target of the Turbo vNAS, you can create a virtual disk on the local server. The Turbo vNAS can be a stack master to connect up to 8 virtual disks or stack targets, aggregating storage space from multiple NAS systems. Thus, all NAS users only need to connect to a single target to access the space from all of the network storage devices.

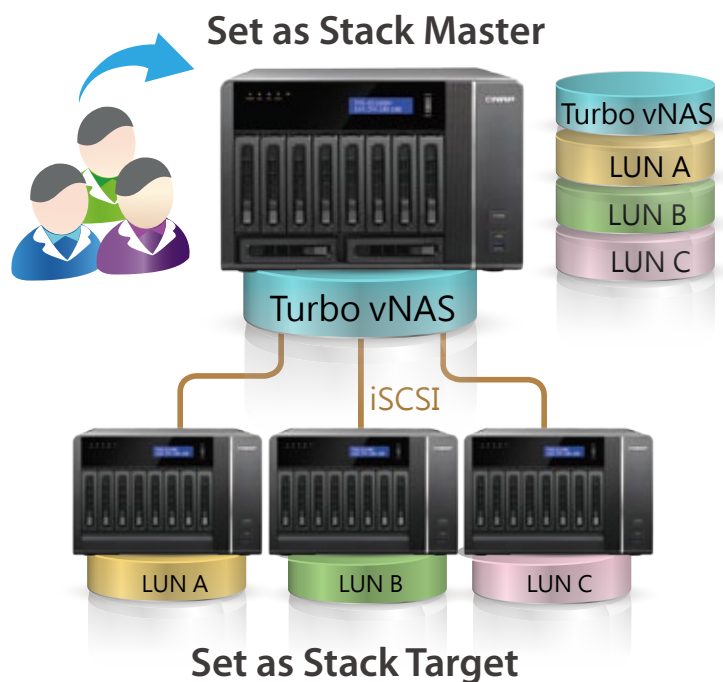

For every virtual disk on the local server, it will be seen as a single drive of disk arrays.

➤ QNAP high-performance unified and tiered storage solutions

Data used by enterprises continues to grow exponentially and with greater diversity in data types and importance. It is imperative to offer a secure and efficient storage solution that can process this enormous amount of data while minimizing the total cost of ownership.

Establishing a tiered storage system based on efficiency and capacity can aid in improving overall processing efficiency. Enterprises can classify data accordingly by sharing folders with a file-based storage system and processing files that require more demanding data throughput with a block-based storage system to accommodate different usage models.

QNAP Turbo vNAS business series can flexibly configure different tiers to hard drives on a single unit according to different data usage needs, delivering the best unified and tiered storage solution.

➤ Tiered storage for better efficiency

In the cloud era, enterprises need a storage architecture that can provide rapid access to dynamically scalable and virtualized IT resources. Classifying data into Hot Data (frequently-accessed) and Cold Data (rarely-accessed) to store them in a tiered storage can help achieve this goal efficiently and cost effectively. Businesses often use SSD to improve the overall workflow of random IOPS demanding applications such as databases and virtualization. Different types of storage media are used for different purposes. Hence, it is better to utilize different storage media according to the system requirements.

	Tier 1	Tier 2
Storage Type	SSD	SATA HDD
Characteristic	Balance of efficiency, capacity and usability	Ubiquitous, convenient, and inexpensive
Usage Scenario	Online transaction processing (OLTP) Systems and ERP databases	Archiving, online and offline backup storage, disaster recovery
Usage Example	Data, audio, email, database table, and video creation and other operations of the workflow in a virtualized environment	Low cost and energy saving
Typical Use	A wide variety of users and environments where performance is crucial	Typical for data at rest
Criterion	Weighs more on IOPS, throughput and resiliency	Weighs more on data volume and low cost per TB

The following is a comprehensive comparison of general tiered storage devices.

Hard Drive	Solid State Drive (SSD)	SATA Hard Drive
Features	Low power consumption, no noise, antivibration, low heat, fast speed	Large capacity, lower reliability and performance
Price	\$\$\$\$\$\$	\$
Capacity	80GB~1TB	500GB~6TB
Performance	Very high	Moderate-low
Interface	SATA (Single Port) 6 Gb/s	SATA (Single Port) 6 Gb/s
RPM	N/A	7200-RPM
External Continuous Transfer Performance	400-500 MB/s	100-170 MB/s
Average Response Time (Milliseconds)	N/A	R:9.5/W:8.5
Input/Output Operations Per Second (IOPS)	120,000/40,000	Less than 100
Unrecoverable bit read error	1 LBA per 10E16	1 LBA per 10E14
Mean Time Between Failures (MTBF, hours)	N/A	0.8 million



File Storage, Management and Sharing

File Management (File Station)

The web-based management interface of File Station allows you to remotely manage, store and share files via web browser from anywhere.



File Station

With File Station, you can easily manage, upload, download, share files, and enjoy media playback anywhere with a web browser. File Station brings conventional file operations performed on the computer desktop to the web browser.

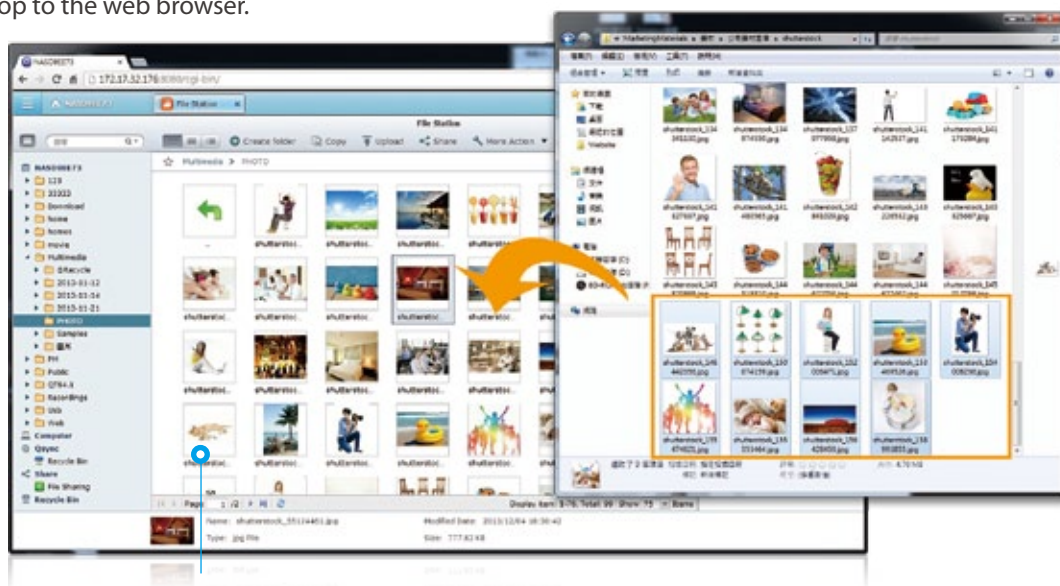

File upload

Easily upload the files to your Turbo vNAS by dragging and-dropping them into File Station.

Photo slideshow

Right-click on selected photos to play a smooth slideshow.

Mutual file sharing

You can easily share multiple files in a shared folder with friends via a Share Link. By activating the file upload function, your friends will be granted the privilege to upload files to your File Station without requiring an user account. You can even set an expiration time for shared files.

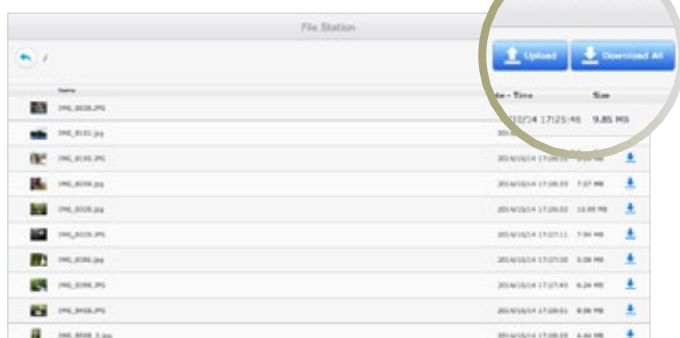

Media streaming & playing

File Station supports VLC for multimedia streaming. Just click on your photos, music and videos to directly play them. The slideshow display helps gather media files in an organized manner for you to preview and play.



Click and play videos

TVS-ECx80+ supports realtime transcoding which allows immediate and smooth video, music, and photo playback. No need to wait for the files to be converted in advance.



Real-time transcoding allows maximum 12 users to simultaneously connect and watch videos. Offline transcoding allows more users. Check page 23 to learn more about transcoding feature.

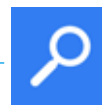
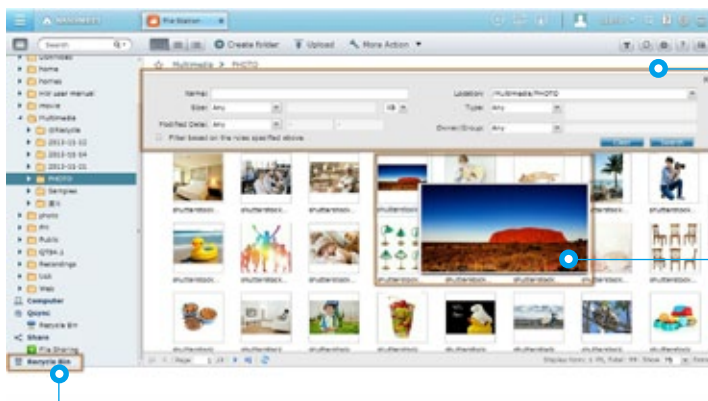
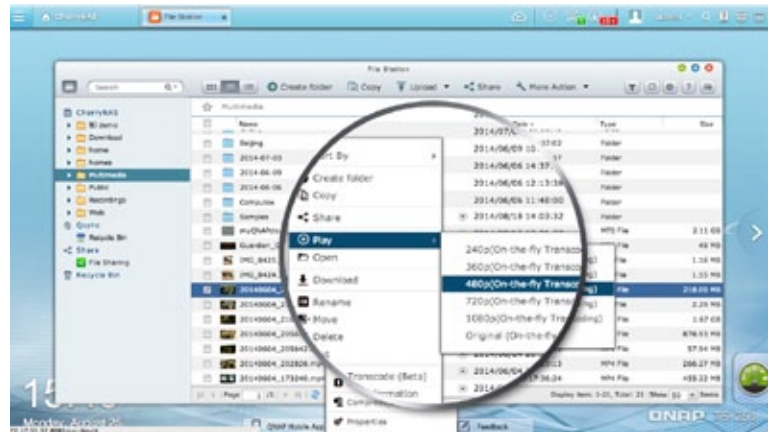

Advanced quick search

File Station provides smart filters for file searching and browsing by file size, modified date, file name, and so on. Pop-up thumbnails enable you to quickly & clearly preview files. File browsing is more intuitive with File Station.



Photo thumbnails preview

File Station makes file management easier by showing thumbnails of photos, music and videos.



Recycle bin

The recycle bin helps retrieve files accidentally deleted. It is categorized by shared folders to increase file retrieval efficiency.

Check shared folder usage and space utilization

The updated user interface of QTS 4.1.2 File Station provides a detailed view of the designated volume and space usage of the shared folders to assist you manage space utilization.

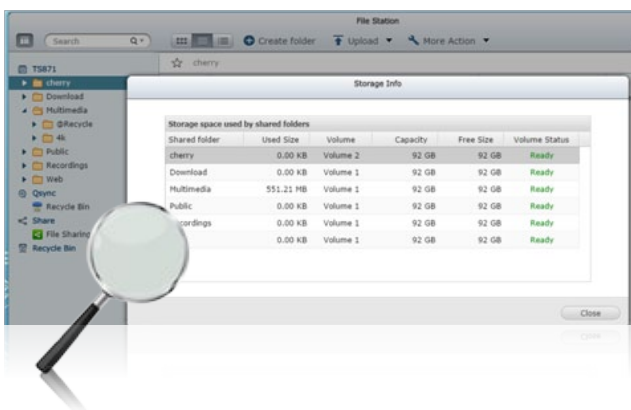

Compress/Extract multiple files

If you need extra space you can easily compress files & folders into a Zip file. You can also easily unzip files straight to File Station.





File Storage, Management and Sharing



Qfile: Share files with mobile devices

You can install the Qfile app on your mobile device to browse and manage files stored on your Turbo vNAS anytime, anywhere.

Access from anywhere

Open Qfile on your mobile device to browse files on the Turbo vNAS. You can open or share files, and easily rename, copy, move, download any selected files.

Auto-upload photos

Automatically upload photos to your Turbo vNAS whenever you take new photos. It works as a real-time backup of your precious photos.

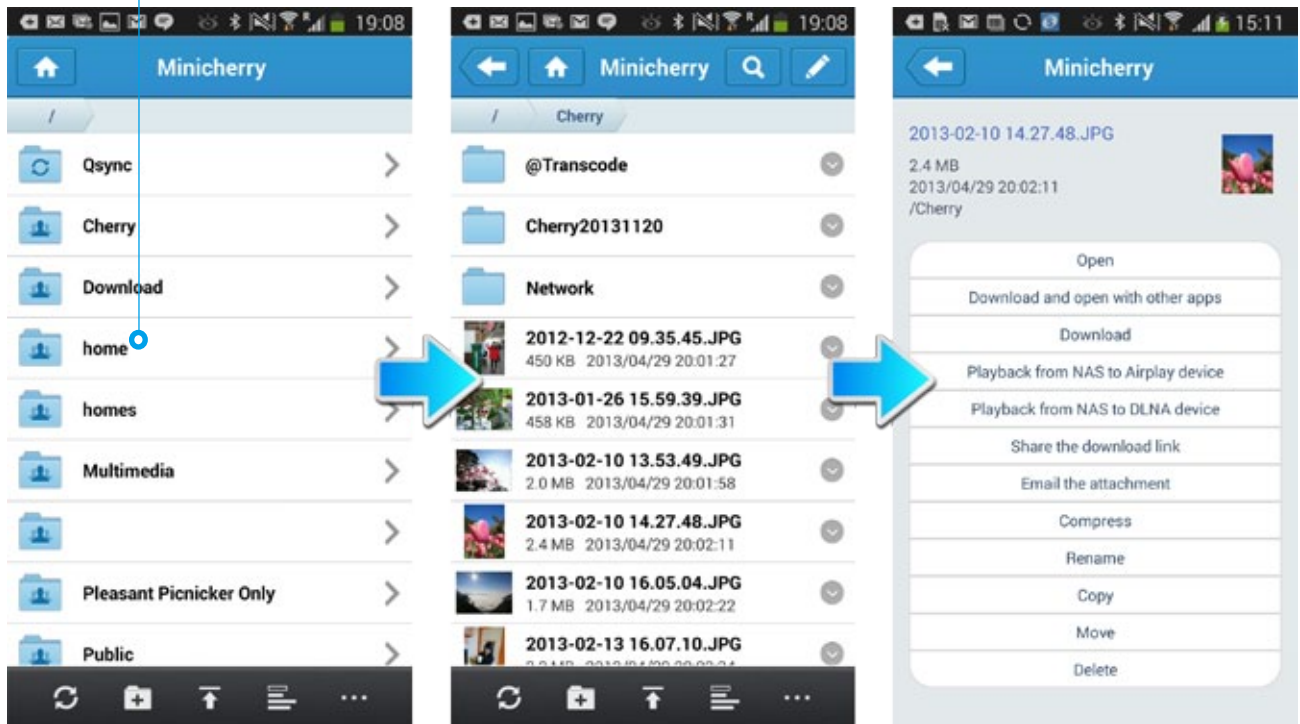

Qfile will download the file to your handheld device and send it via your default email function. This file cannot exceed 20MB, so please ensure there is enough free space on your device to save the file.



Install Qfile on your mobile device to browse and manage files stored on your Turbo vNAS anytime, anywhere.



Stream multimedia contents

Use Qfile to stream multimedia contents to AirPlay or DLNA-compatible devices and play to enjoy them.

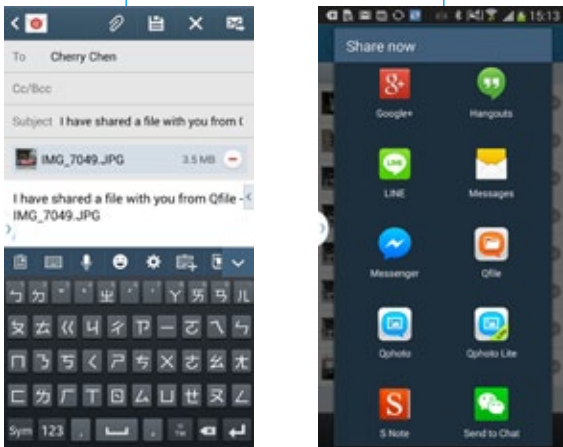
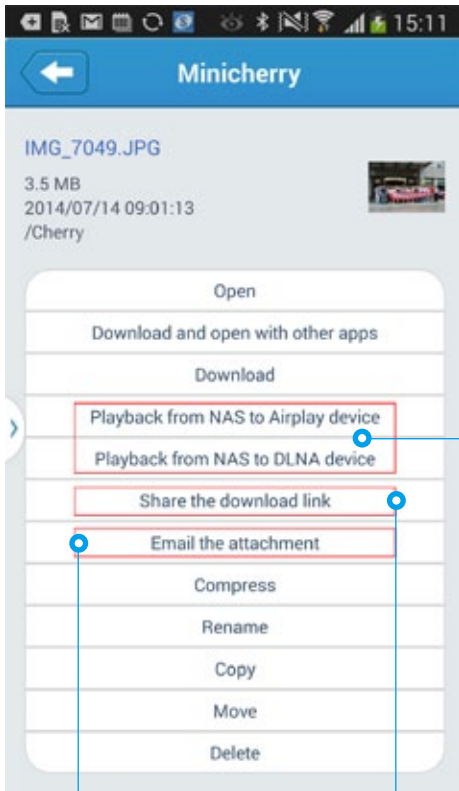

Share files instantly

Qfile provides various ways for instant file sharing, including email or SMS. Qfile also provides Share Links to easily share large files. You can paste the Share Link on instant messenger such as LINE, WhatsApp, WeChat, and more to share files with others.

Your friends can click on the Share Link to download the files.

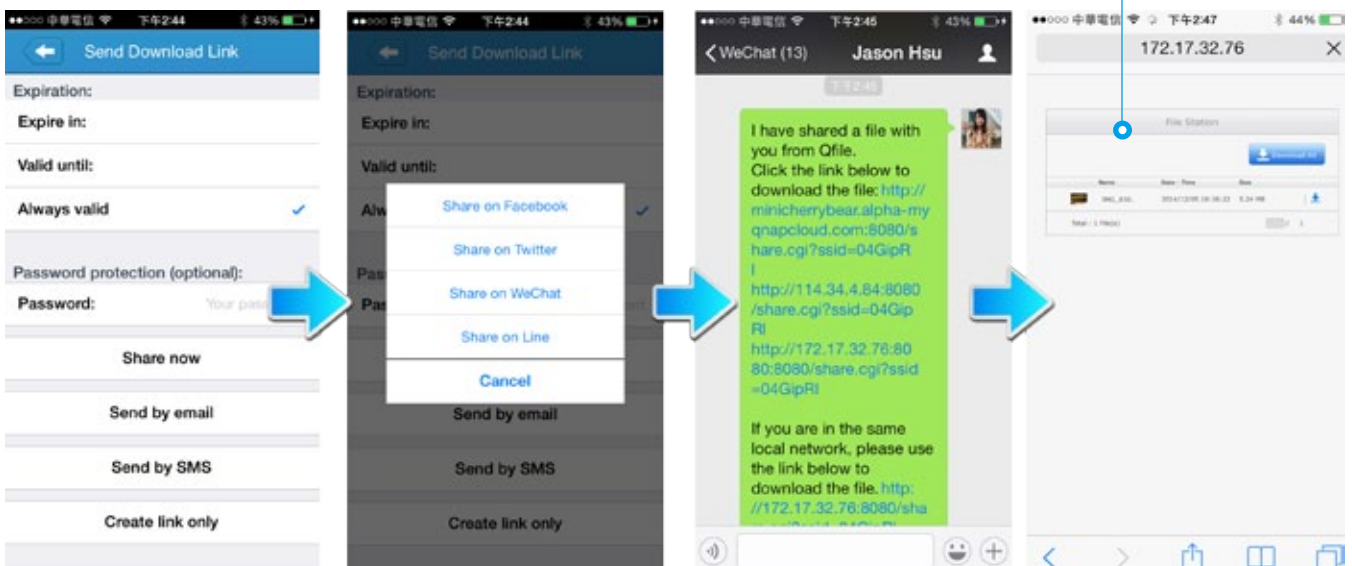



Q'center CMS (Central Management System)

Previously, IT administrators need to log in to Turbo vNAS units individually to check their status. The QNAP Q'center CMS (Central Management System) offers a platform to centrally manage multiple NAS units. You only need to install Q'center on the master NAS and set all other Turbo vNAS units as managed stations. You can also monitor and update firmware for all Turbo vNAS units at once with this centralized management utility.

Q'center Network Architecture

In order to use Q'center to monitor multiple Turbo vNAS units, you have to set up the master Turbo vNAS and other managed devices in the same network environment. QTS 4.1.2 provides the VPN server and VPN client function, making it easy for IT managers to establish the internal network architecture for Q'center deployment. Just set the master device as a VPN server and other devices the VPN clients, and the internal network environment will be established by VPN protocol automatically.



The Best Utility for IT Administrators

➤ Increase IT Management Efficiency

1. User-Friendly Management Interface

Not only can you monitor the system status for all Turbo vNAS units, but you can also view their firmware information and system logs. You no longer need to log in to NAS units individually for such information. Besides viewing system information, IT administrators can update the firmware for all Turbo vNAS units at once with a single click.

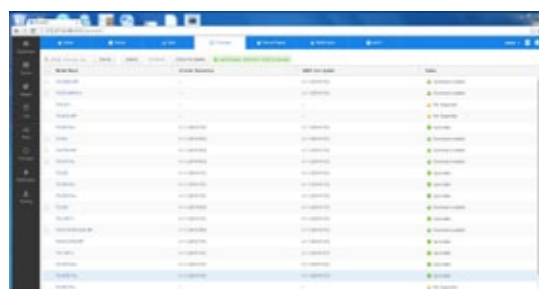

2. Simplify IT Asset Management

Q'center presents overall reports of all Turbo vNAS units based on the characteristics of a NAS system or its components such as model or disk capacity, helping you keep track of all your storage assets.

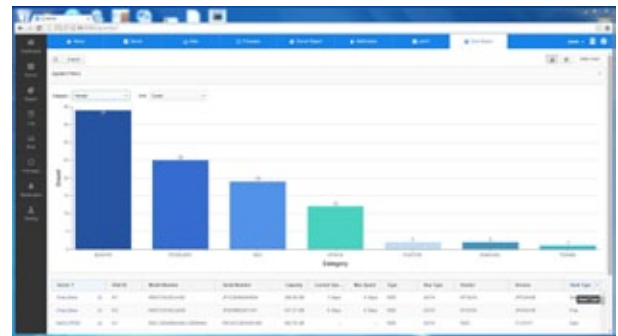
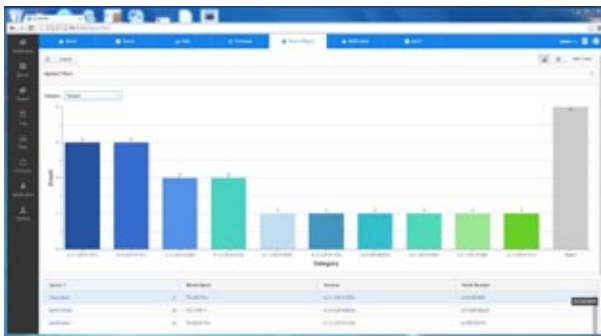

➤ Enhance System Availability

Q'center has an email notification function to notify administrators of any predefined system conditions. You can set up alert policies based on the criteria such as CPU usage or volume usage for a group of selected NAS units, and you will be alerted if any one of the criteria of a policy is met.

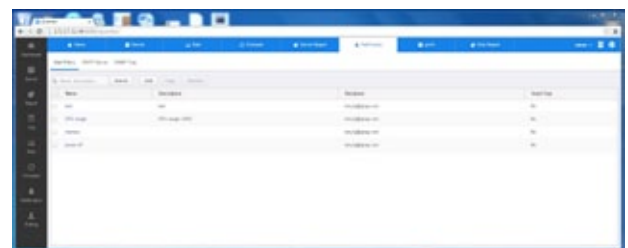

➤ Increase Storage Utilization Rate

IT administrators can monitor capacity usage on every Turbo vNAS to gain insight about space utilization. They can better allocate storage resources accordingly to maximize the utilization rate for each Turbo vNAS.

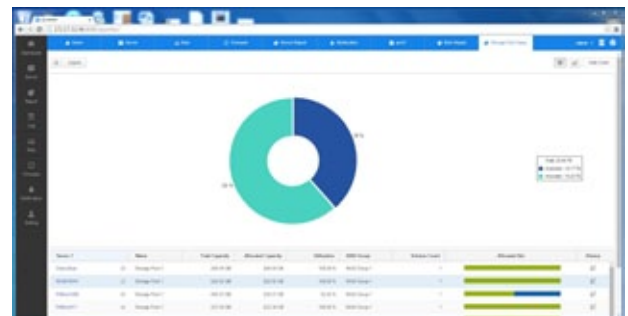

➤ Enhance Reliability and Serviceability

By monitoring CPU, memory usage and other performance indicators on a daily or long-term basis (e.g. monthly or yearly), you will gain a complete view of how well the system performs. You can also analyze how certain tasks (such as download, file conversion, or encryption) affect the overall system performance. Furthermore, IT administrators can check system performance anytime to help them redistribute tasks or loads among NAS units or upgrade their systems when they are running on resources.

The report function can generate a series of charts and graphs that display system information to help IT administrators proactively plan system upgrades and respond to system failures or degradation, as well as evaluate how the effective storage is used. Statistics collected can be kept for an entire year for capacity planning.





Virtualization Station



Virtualization Station

The TVS-ECx80+ series supports Intel VT-x and virtual machine applications. Just download Virtualization Station from the App Center, and you can install & operate multiple operating systems including Windows, Linux, and UNIX. The virtual machines can be used in a variety of different ways to boost the functionality of your Turbo vNAS, just like having multiple computers with you.

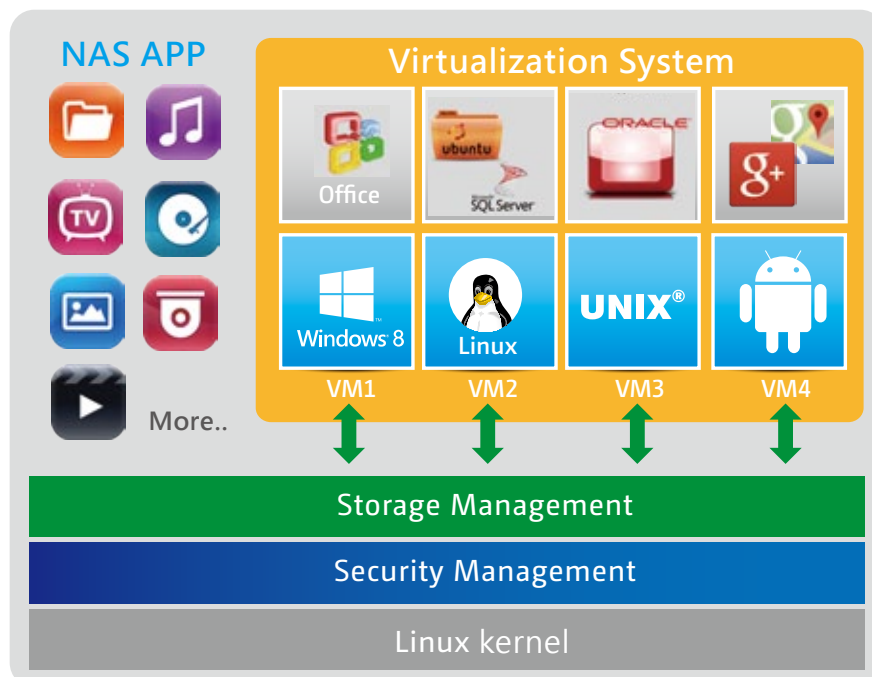

Virtualization technology is normally used in enterprise IT environments, but with the growing needs of a digital office, virtualization is now our everyday applications. Many offices have printers, and when users want to print the documents stored on their Turbo vNAS and realized that the printer requires a Windows-only driver, they will need to boot up their PC just for this simple task.

Create multiple VMs on TVS-ECx80+

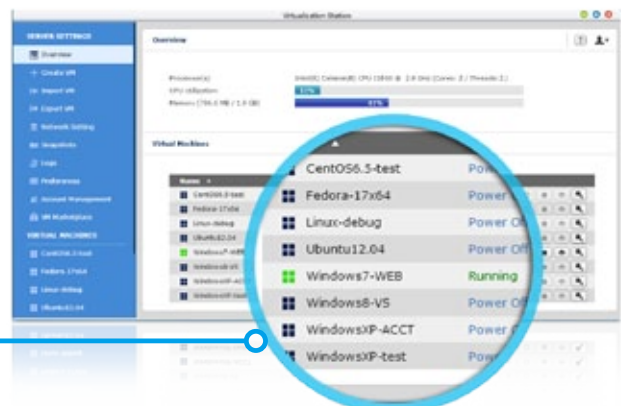

You can carry out the above scenario in a VM using the below steps.

- 1 Download Virtualization Station from the App Center and create a Windows-based VM
- 2 Install the printer drivers in the VM
- 3 Map the destination folder into the Windows-based VM and set the folder as a network drive
- 4 Access the VM remotely via a web browser to select a photo and then print it



* The network usage of Virtualization Station is isolated from the Turbo vNAS. One Ethernet cable is reserved for the Turbo vNAS, and so you will need to connect at least one more cable for the Virtualization Station.



How to map the destination folder into a Windows VM? Please follow these steps: (Using Windows 7 as an example)

- A Go to "Computer" and click "Map network drive"
- B Please enter the IP address of your Turbo NAS and click "Browser". Select the folder you want to use and click "Finish".
- C This folder will appear as a network drive on your "Computer"

➤ USB devices (USB Passthrough)

QNAP Virtualization Station supports connecting USB devices to virtual machines. Commonly used USB devices can be connected to virtual machines, and you can select the device using Virtualization Station.

This can be used together with QVM Desk just like a PC. For document management, you can connect USB card readers/scanners to a Turbo vNAS via Virtualization Station and store scanned data directly to the Turbo vNAS without taking up Internet bandwidth.

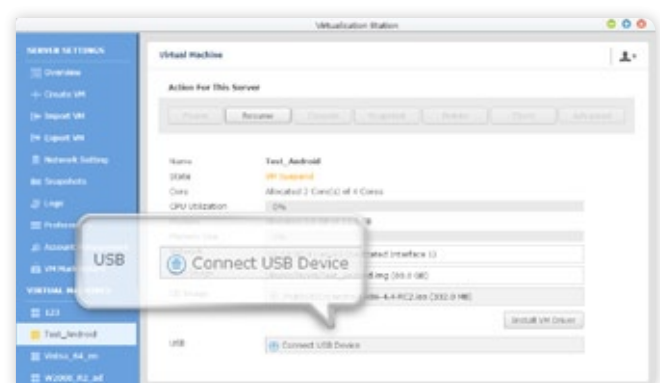



▶ The highlights of QNAP's exclusive virtualization technology

Direct access to files & data via VM

Specific file formats cannot be opened directly by the Turbo vNAS, but the Virtualization Station makes it possible. Administrators can install Windows, Linux, and UNIX on the Turbo vNAS to run any supported application or file.

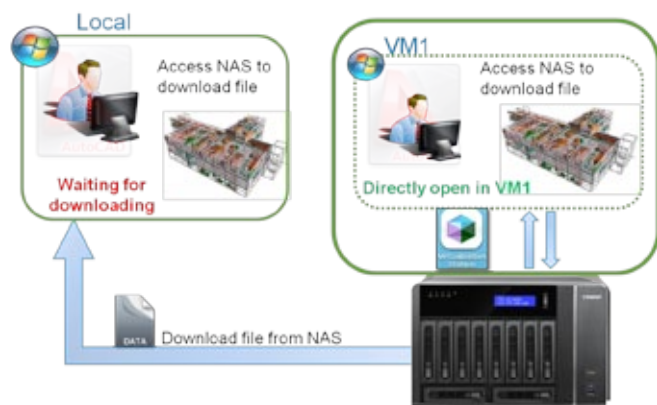

Save bandwidth & time

Downloading a large amount of data to a local PC can take a long time and use up network bandwidth. When accessing data on the Turbo vNAS through virtual machines on the Virtualization Station, you can enjoy secure data transmission and save bandwidth & time as the data is not transmitted via physical network cables.

Enhance security and save bandwidth

When accessing files & data on a virtual machine they are not transmitted outside of the Turbo vNAS. This provides a secure environment that prevents sensitive data from being intercepted and also saves bandwidth & network resources when you need to access large files.

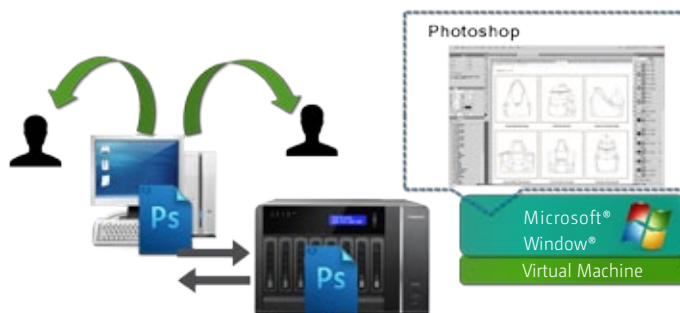

Dedicated network for VM only

The Virtualization Station provides functions for network monitoring. You can monitor all NIC (network interface controller) traffic and assign a specific NIC exclusively to a single VM.

User-based permissions settings

The Virtualization Station administrator can create users and set proper permissions for each Virtual Machine (VM), helping to efficiently manage and allocate VM resources for users with different needs. With these permissions, users can work independently on their VM without worrying about their work being interrupted or data being lost because another user has accidentally powered-off the VM.

User-based permissions include:

Console permissions: Control and View-only

VM controls: Snapshot and Advanced

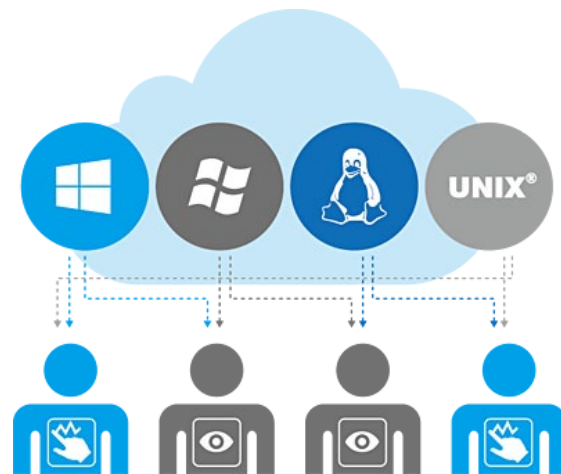

Operate VMs as Remote Desktops

Enjoy utmost convenience by operating Windows, Linux and UNIX-based VMs as remote desktops. A list of buttons is provided on the left side of each individual VM display, allowing users to suspend, shutdown, force shutdown, reset, bring up key combinations **Ctrl + Alt + Del** & function keys, and even take snapshots for the VMs.



QNAP QVM Desk

QNAP QVM Desk supports local display for deploying virtual applications on a big screen when connected to a HDMI monitor, keyboard, and mouse. Compared to webpage operations it's smoother, more secure, and worry-free to do on a Turbo vNAS. Even when Internet connectivity is limited, you can still access data and run virtual machines on a Turbo vNAS.

Budget-friendly QNAP Turbo vNAS for cloud computing

To meet the growing demand of cloud computing, solution providers offer a variety of services to their customers. Customers can leverage computing or application services with cloud computing in lieu of system maintenance and configuration. However, public cloud services can have shortcomings. Complying with high standards of security and evolving regulations as well as controlling long-term operating costs are among the major concerns of public cloud services. Most cloud computing pricing depends on the amount of resources consumed such as computing power and a subscription period. The integrated Virtualization Station of QNAP Turbo vNAS can help your enterprise develop a cost-effective strategy with the aforementioned tiered and unified storage to manage and store your data, potentially maximizing storage capabilities per TB. It is the industry's best private cloud architecture to counterbalance the disadvantages of public cloud services.

	AWS EC2	Rackspace Public Cloud	TVS-x80+ Series Virtualization Station	VMware vCHS	Google IaaS
Capacity	vCPU Cores: 2 Memory: 7.5 GiB Storage: 32G SSD (m3.large)	vCPU Cores: 4 Memory: 4GB Storage: 80 GB SSD (General 1-4)	vCPU Cores: Max. 8 Memory: Max. 30GB Storage: 50TB SSD	vCPU Cores: 2 Memory: 8GB Storage: 80 GB SSD	vCPU Cores: 2 Memory: 7.5GB Storage: 375 GB SSD
Available Region	Global	Global	Global	U.S.	Global
Operating System ¹	Windows Server	Windows Server	Windows, Linux, Unix and Android ³	Windows Server	Windows Server
Price ²	\$0.266 / hr	\$0.188 / hr	One-time investment	Calculated annually	Calculated annually

¹Cloud CPU capacity measurement varies from vendor to vendor; here we only present it with vCPU core numbers.

²The prices shown here are directly replicated from service providers' websites.

³The price does not include OS license fees for Virtualization Station.



Deploy Enterprise Cloud Computing with the integrated Virtualization Station

Powered by an Intel® Xeon E3 v3 processor and DDR3 RAM, the TVS-ECx80+Turbo vNAS series supports Windows Server 2012 R2 Virtualization. Every virtual machine on the Turbo vNAS can be allocated with 8 virtual processor cores, 30 GB memory, RAID storage, and virtual IO (VirtIO). It is ideal for deployment of compute-intensive IT applications and cloud-based business processes, including AD server, domain controller, Exchange server SQL server and enterprise resource planning (ERP) system.



Virtualization performance

Compared to the same physical hardware of the TVS-ECx80+: the performance transmission of a VM in Virtualization Station retains 91% of the native CPU, 84% of HDD read, 85% of HDD write and almost the full capacity of the network transfer bandwidth.

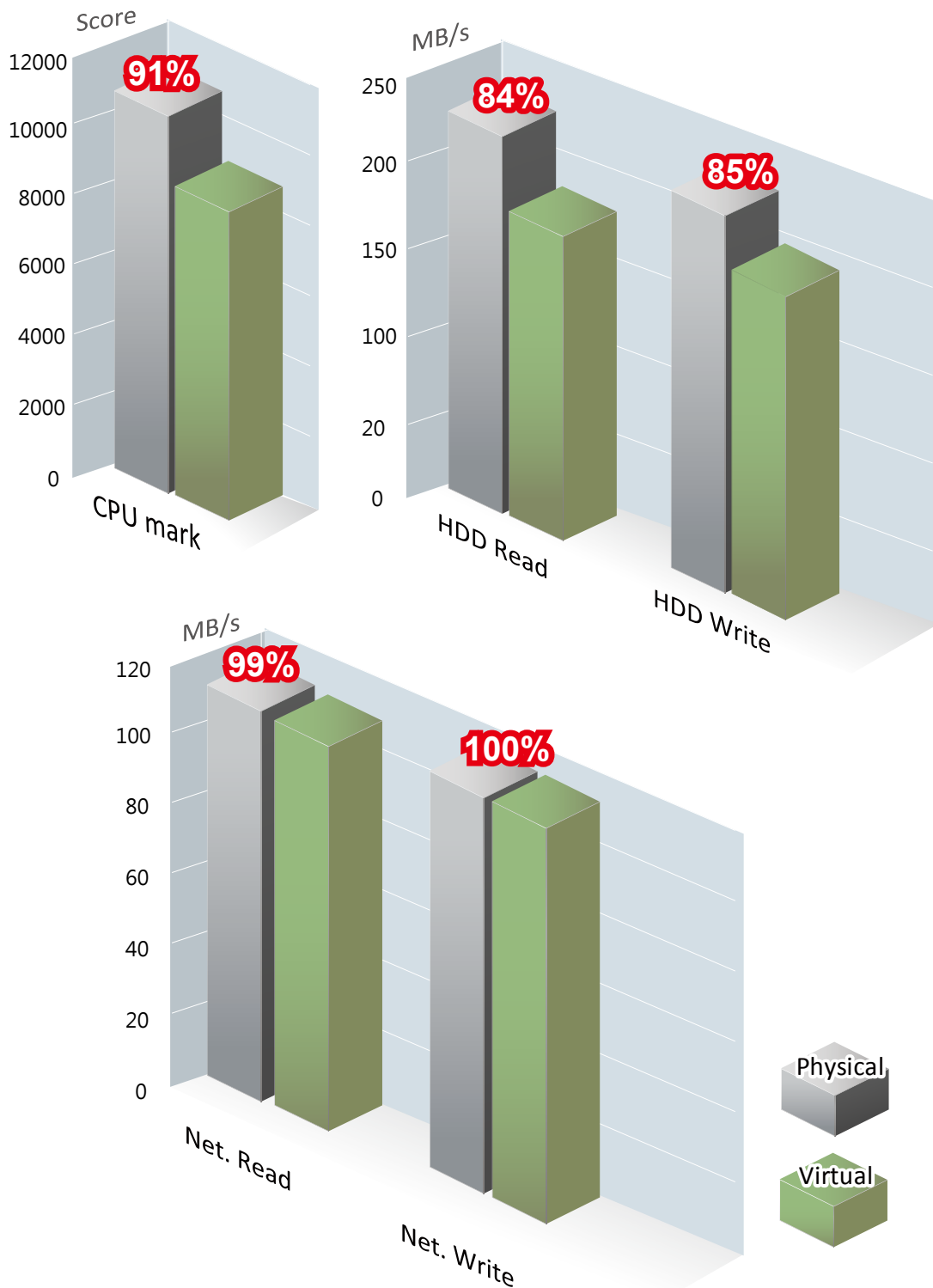

* Intel Xeon E3-1245 v3 3.4GHz; sequential read/write 1024K file; continuously uploading 64K file and downloading 60K file
* Test environment: Windows 7 64bit; single disk Seagate 6G Enterprise Capacity 35 HDD v4 (VirtIO); 1GbE LAN (VirtIO)



Powered by QNAP's exclusive QvPC Technology

With the growing trend of "Software-defined everything (SDx)" in today's IT environments, QNAP has taken the lead in offering the exclusive QNAP virtualized Personal Computer (QvPC) Technology that allows you to use the Turbo vNAS as a PC. All you need to do is plug in a monitor, keyboard and mouse to be able to operate the system via "HD Station (HybridDesk Station)" on the screen.

About QvPC Techonology

Based on Software-defined Everything, QvPC Technology is the result of years of R&D effort that QNAP has put into developing and perfecting its software and hardware expertise. QvPC Technology has consolidated a number of high-end technologies and latest IT trends including VM integration, multimedia transcoding, HDMI output, cloud integration, and NAS connection technologies, allowing users to operate Turbo vNAS as a PC when they plug in a keyboard, mouse and monitor. QvPC Technology can turn a NAS into a low-cost & high-performance 2-in-a box NAS that can function as a NAS and a PC. Whether you are working in a studio or at a remote site, you are assured to receive the best user experience. QvPC Technology features HybridDesk Station (HD Station) as the user interface, which consists of QVM Desk, Defense Desk, and Local Display Desk and provides SMBs various software applications.

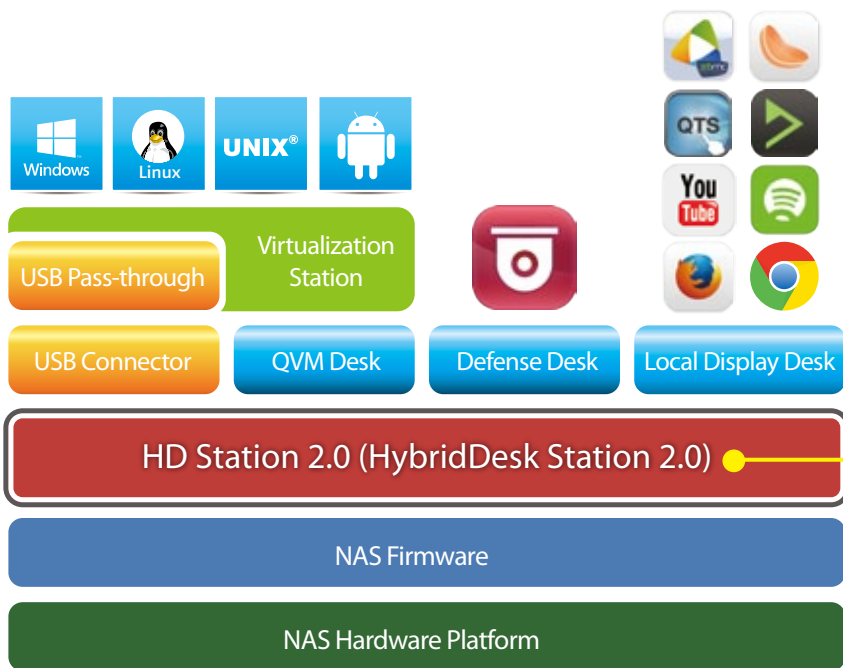

Connect a monitor with a HDMI cable, and you can enjoy a variety of applications with HD Station 2.0. You can initiate the service in QTS system and install different applications according to your needs.



* All trademarks in this brochure are the property of their respective owners.



The highlights of QNAP's exclusive QvPC Technology

▶ HD Station 2.0 (HybridDesk Station 2.0)

HD Station 2.0 is a monitor-based user interface based on QNAP's exclusive QvPC Technology. Simply plug in a keyboard, mouse, and HDMI monitor to a TVS-ECx80+, and you can start the installation process and access data without connecting to a PC, tablet, or smartphone. <HD Station 2.0 >. A variety of local display applications are available on HD Station including QTS, Google Chrome, QVM, XBMC, and Surveillance Station.



HD Station 2.0 is touchscreen enabled. Simply plug in a touchscreen monitor and start using it immediately

Streamlined installation: No complicated procedures necessary to install your Turbo vNAS.

After purchasing a Turbo vNAS, users usually install firmware from an installation disc and search for the Turbo vNAS on their network, or log in to the NAS manufacturer's website to complete the installation process. For users without relevant networking knowledge, this installation process may be difficult. Some users decide to purchase other external storage devices that can be instantly used (such as USB hard drives). However, these devices are "islands of information" that can only be accessed by the computer they are connected to. These storage solutions also offer no protection against failure, and are easily misplaced.

A Turbo vNAS is an ideal solution for storing data. With QvPC Technology users only need to plug in a HDMI monitor, keyboard, mouse and follow on-screen instructions to complete their NAS installation. Even users without any network knowledge can easily set up and install a Turbo vNAS. All files stored on a Turbo vNAS are protected with RAID technology and are accessible via the Internet anytime.

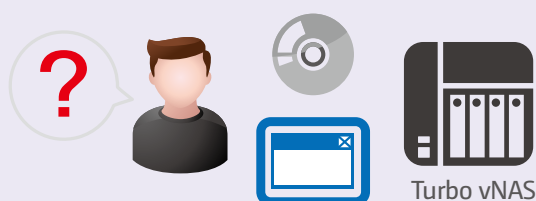

Conventional installation: You need an disc or to log in to a website to complete the installation, and it can be complicated for general users.



Streamlined installation: simply plug in a monitor, keyboard and mouse and follow the on-screen instructions to complete the installation.



QNAP QVM Desk turns a Turbo vNAS into an office PC



Run Windows, Linux and Android virtual machines on a HDT V

Leveraging the virtualization technology, QNAP QVM Desk supports local display for a virtual interface and turns the Turbo vNAS into a PC when connected to a HDMI monitor, keyboard, and mouse. Any files on the TVS-ECx80+ series can be opened using virtual machines running Windows, Android, Linux, and Unix through QVM Desk. You can also instantly switch between different virtual machines to meet your needs, just like using multiple PCs at the same time. Compared to the operations via a webpage, it's smoother, more secure, and worry-free to do on a Turbo vNAS. Even when the Internet connectivity is limited, you can still access data and run virtual machines on a Turbo vNAS.



Linux



Windows



Android

Run Android on a NAS with QvPC

Have you ever feel constrained by the lack of storage space on your tablet or smartphone and have no idea where to back up your files or what apps to delete for more space? With QvPC Technology, you can run Android on a virtual machine, and back up apps or files like LINE, WeChat, Gmail, your phonebook, photos, and chat messages from your Android device to the virtual machine with backup software like App Backup & Restore and My Backup Pro. This way, the files on the public cloud can be stored on your private cloud. You no longer need to worry about having difficulty accessing your data anymore. In addition, your NAS can be transformed to an Android device and the millions of apps on Google Play can be operated on it as well.



To learn more about QNAP Virtualization Station, please turn to Page 11.



Defense Desk 24/7 safeguards your office and property*

Live-view

QvPC Technology supports local display of live surveillance feeds on the screen with a QNAP remote control. You don't need an additional PC for live-view, nor do you need an Internet connection to check the stored video recordings. You can monitor up to 36 channels simultaneously, adjust PTZ functions, and conduct audio surveillance. QvPC also supports instant notification functions and will show alerts on the monitored page should any incident happens, helping you take immediate action and control the work environment more efficiently.

Playback

You can connect your Turbo vNAS to a monitor to playback recordings. Just select a timeframe, and you can search the recordings within this period. It also supports video fast-forwarding and rewinding (up to 16x speed). You can quickly look for detailed images with the zoom function, and listen to audio for key background sounds during the playback.

* Available soon



To learn more about QNAP Surveillance Station, please turn to Page 29.

Manage Local Display Desk easily



Quickly install QTS and access files

Just plug in an HDMI monitor/TV, keyboard and mouse to a TVS-ECx80+, and within a few simple steps you will complete installation and be able to access files using the QTS operating system.





Surf the web via Chrome/Firefox on TV

QvPC Technology supports HDMI-out and Google Chrome/Firefox, allowing you to surf the web easily, and is ideal for offices to build an information search center with minimal costs.



Build an online music center with Spotify

Over a million songs can be found on Spotify. Create a media center and enjoy your music collections with your NAS while at work.



Qremote mobile app turns your mobile device into a handy remote control

iOS® and Android users can download the Qremote app to turn their smartphones into a remote control to conveniently play videos, music, and photos on TV via HD Station 2.0. The Official XMBC Remote app can also be used.

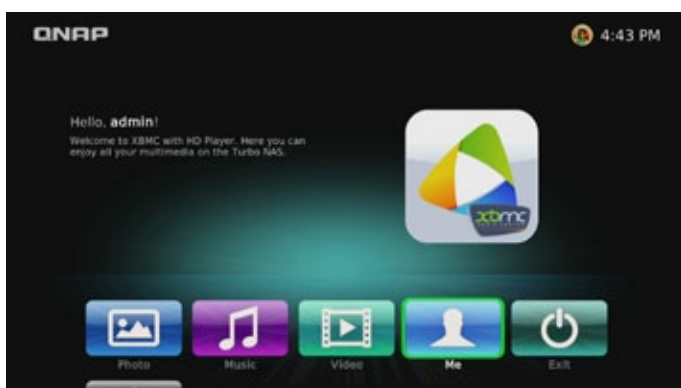



QNAP's Unique Transcoding Technology

Every year many SMBs produce hundreds of promotional videos for marketing purposes. However, due to the increasing use of HD videos (720p, 1080p), video files are becoming increasingly large in size and can use lots of network bandwidth to share or play them over a network.

Transcode Management

With the popularity of high-definition smartphones and digital cameras, video resolutions are getting higher. A higher resolution means larger file sizes and more bandwidth needed to stream it. Transcoding creates videos with optimal resolutions for sharing & watching in order to save bandwidth, but also retains the unaltered original video on the Turbo vNAS.



Smart transcoding adapts to suit different bandwidth

The TVS-ECx80+ series provides a range of resolutions to play/share videos according to different bandwidth limits. Higher resolutions need more bandwidth, and you can select the right resolution for your network environment to get the best viewing experience.

Resolution \ Network	240p	360p	480p	720p	1080p	4K2K
Ethernet						
Wi-Fi (108.11 ac)						
Wi-Fi (108.11 a/b/n)						
4G (LTE)						
3G						



Multi-mode transcoding function

Background hardware-accelerated transcoding

The TVS-ECx80+ fully supports offline background transcoding for 4K (H.264) videos. Just add videos to the transcoding list and use the Turbo vNAS to convert the original high-resolution video for use with multiple resolutions. Then you can select an appropriate resolution when sharing or watching to match your device or network environment.

Auto transcoding

When you set a folder on the Turbo vNAS to be an auto-transcoding folder, videos added to it will be automatically converted to a resolution you have set. For example, if you set the folder to 360p, videos added to this folder will be automatically transcoded to 360p as a background task.

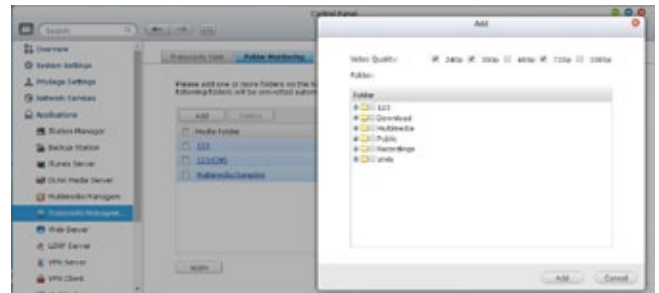

On-the-fly transcoding

If you have many high-resolution videos, but did not transcode in advance, you can use on-the-fly transcoding. This will adapt to meet bandwidth limits, with the Turbo vNAS transcoding in real time for directly watching the video.



Embed subtitles

By selecting the Embed Subtitles option in the Transcode Management function, you can embed subtitles to a video when converting a video to any resolution. The subtitles will then be displayed when a video is played on whatever device you are using.

Hardware-accelerated transcoding technology

With Intel® HD Graphics, video creation & conversion is faster, easier and can significantly reduce the time needed when handling multiple on-the-fly transcoding tasks.

Performance

Compare the transcoding time between the TVS-EC1080+ and TS-670 with using the same high-resolution (1080p) video. Powered by an Intel Pentium® CPU with QNAP's exclusive transcoding technology, the TVS-EC1080+ is 16 times faster than the Celeron®-based TS-670.

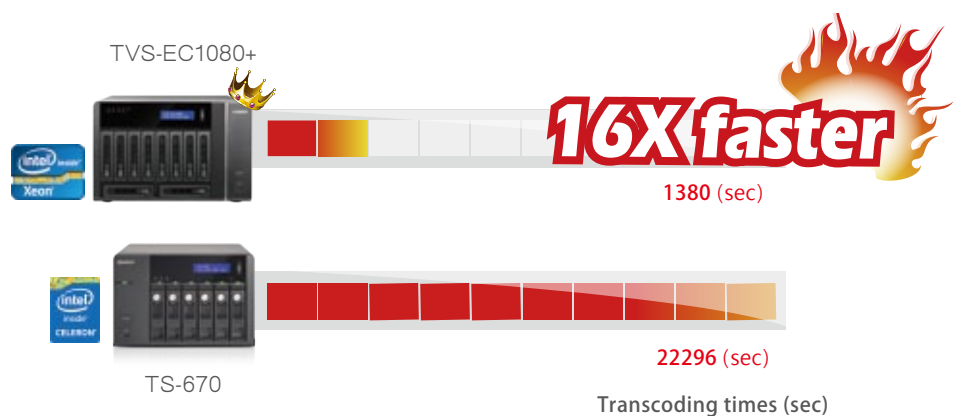

Test environment: The time spends for a two-hour video with 1080p resolution and in mkv format.



Virtualization Applications

The Turbo vNAS supports iSCSI & NFS protocols and is virtualization ready with compatibility for VMware®, Citrix®, and Microsoft® Hyper-V to provide businesses with powerful & flexible storage solutions for virtualization applications.

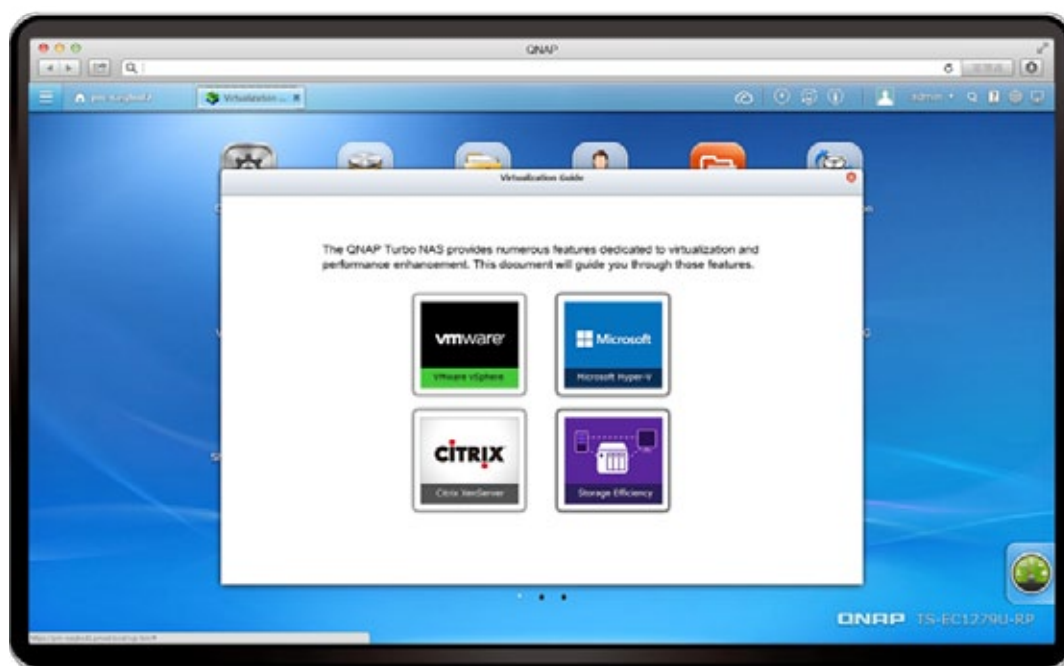

➤ Virtualization ready

The Turbo vNAS supports iSCSI & NFS protocols and is virtualization ready with compatibility for VMware®, Citrix®, and Microsoft® Hyper-V to provide businesses with powerful & flexible storage solutions for virtualization applications.

➤ VAAI/Hyper-V Plug-in Support

Use the free QNAP vSphere Client plug-in and QNAP SMI-S provider for SCVMM and managing the Turbo vNAS from the virtualization management client console is easy.

➤ Secure and flexible storage utilization

The Turbo vNAS offers flexible management through creating and allocating iSCSI LUNs (Logical Unit Numbers), mapping and unmapping LUNs to and from iSCSI targets, and thin provisioning. CHAP authentication and LUN masking support reinforces secured deployment in virtualization applications.

➤ NAS/IP SAN unified storage

QTS supports NFS and iSCSI/IP-SAN storage solutions that can be utilized as network-shared storage of virtualized environments, helping to achieve an efficient cost-saving, energy-saving optimized storage capacity.

VAAI for iSCSI, VAAI for NAS

The Turbo vNAS supports VMware VAAI for iSCSI and VAAI for NAS. Businesses can select either iSCSI or NFS as a centralized storage to boost performance. VAAI for iSCSI supports Full Copy (hardware-assisted copy), Block Zeroing (hardware-assisted zeroing), Hardware-assisted Locking, and Thin Provisioning with space reclaim. VAAI for NAS supports Full File Clone, Extended Statistics, and Reserve Space. The QNAP Turbo vNAS supports VAAI iSCSI and VAAI NAS to enhance storage performance in a virtualized environment.

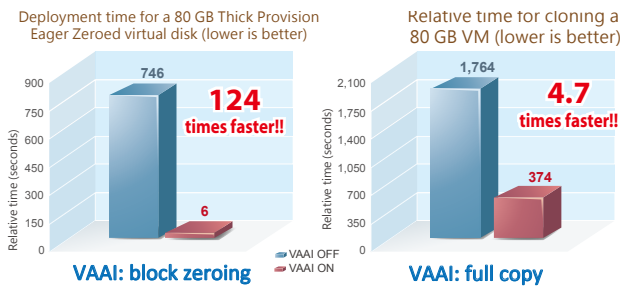

QNAP Turbo vNAS: Boosted Performance by ODX

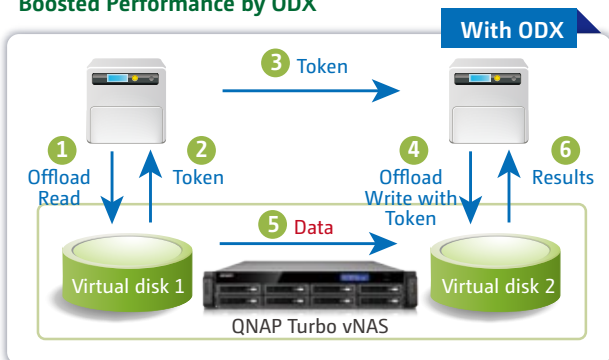

Other NAS

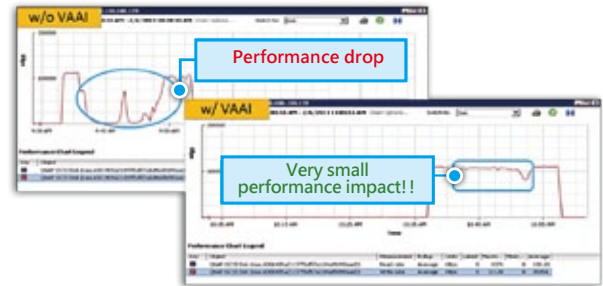
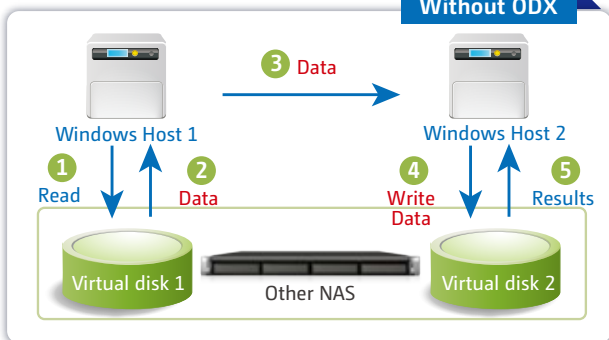

VAAI: Hardware-assisted Locking

Storage for Microsoft Hyper-V

With ODX support, the QNAP Turbo vNAS becomes a high-performance iSCSI solution under Windows Server 2012, including Hyper-V virtualized environments. QNAP storage enables full copies of virtual machines within the NAS without requiring the Windows hosts to read and write the data to highly reduce the load on Windows hosts and improving the performance of copy & move operations on Windows 2012 hosts. When providing QNAP storage to a Windows 2012 file server, the end user using a Windows 8 client workstation will also benefit from the Offloaded copy process for large file transfers.

NAS management via SCVMM

QNAP SMI-S enables management of the QNAP Turbo vNAS directly through Microsoft System Center Virtual Machine Manager 2012 (SCVMM)



vSphere plug-in

The vSphere plug-in allows users to manage the QNAP Turbo vNAS directly on the vSphere client, making datastore management more effective.

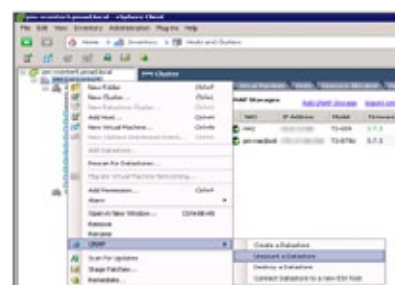

5 Major Applications for Enterprise

Multipurpose workstation for enterprise IT environment

1

IT Management Station



Powered by Mandriva® Pulse, IT Management Station is designed to simplify daily tasks and IT asset management for businesses of all sizes. Your Turbo vNAS becomes an IT system management server to help you centrally manage multi-OS & multi-site IT resources, applications and security with greater flexibility.

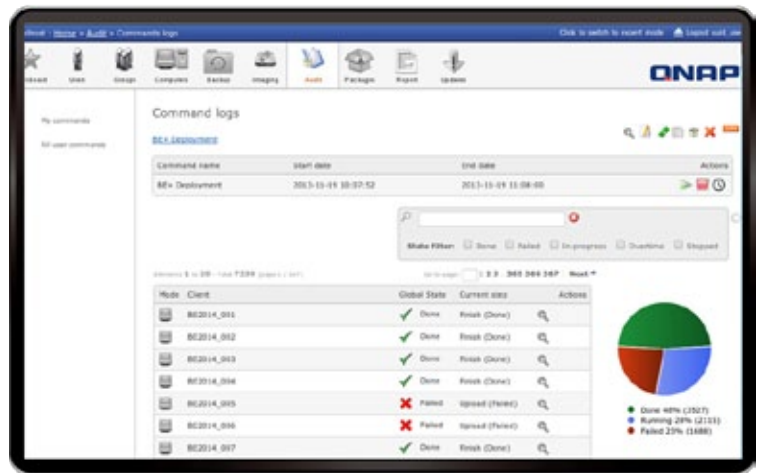

At the core of Pulse



Comprehensive Inventory

Pulse automatically retrieves hardware & software information from your IT system using an inventory agent to provide you with reliable and timely data. It measures the potential of your inventory and runs your IT assets tactfully, thanks to dynamic groups, self populated from queries.



Mastering

Create generic disc images to carry out mass OS deployments.



Remote Control

Help your users in their everyday tasks by connecting from remote locations without compromising the security of their IT assets.



Cloning

As part of a scheduled or on-demand restoration, systems and their stored data can be fully backed up easily.



Deployment

Design, schedule and implement software installation on your IT assets.



Backup and Restore

Save time, optimize storage and protect data from accidental loss using incremental backups.

➤ New features in Mandriva Pulse 2.0

Reporting

Create and edit reports/graphs for better control of your IT assets and to anticipate future changes.

Pull Mode

Increase the compliance of your roaming devices for deploying packages needed in any environment.

License Management

Optimize your software assets with an overview of used and available licenses.

Update Management

Centralize your software updates for greater control and security.

Software Convergence

Efficiently deploy software using an automated process.



➤ Flexible management of your IT assets

Multi-OS

Manage all your IT assets and virtual machines no matter if it is Windows, GNU/Linux, Mac or Unix.

Multi-site

Remotely & securely manage your sites via SSH tunnel, simultaneously controlling the bandwidth and conserving the availability of your network.

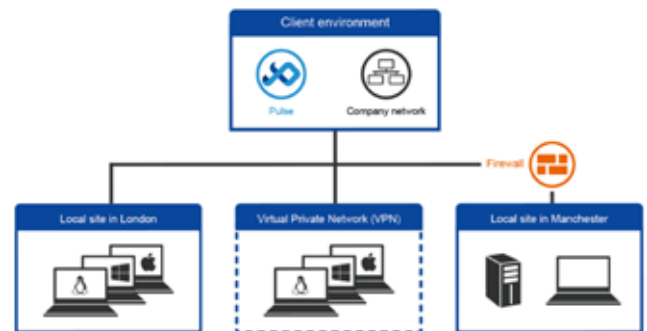

➤ Intuitive tools

Features a desktop icon for quick self installation to facilitate access and remote control of new deployments.



A simple web interface with an intuitive dashboard for quick information regarding your IT assets.

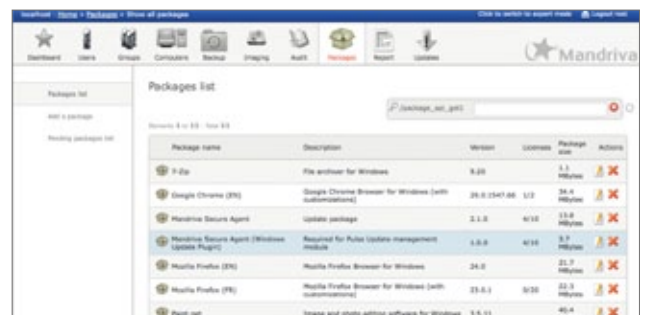

A unique management interface for software licenses and automatic package management.



2

Surveillance Station



One of the standard Turbo vNAS applications, the Surveillance Station is professional network surveillance Video Management System (VMS) that can be activated in the QTS App Center to turn the Turbo vNAS into a professional Network Video Recorder (NVR) system for real-time monitoring, recording, playback, alarm notifications, Intelligent Video Analytics (IVA), and management to safeguard your assets and property when used with supported IP cameras. The TVS-ECx80+ series comes with 8 free camera channels, allowing users to easily build a surveillance system.



8 free camera licenses

Highly-professional NVR system

Wide range of supported IP cameras

Surveillance Station is compatible with over 2,700 IP camera models across over 90 brands and ONVIF specifications, including those that support advanced features such as multi-streaming and fisheye dewarping.

Comprehensive Turbo vNAS support

TVS-ECx80+ offers 8 free IP camera channels and can be expanded to 80 channels to fulfill various surveillance deployment needs.

Cross-platform support

Surveillance Station works with all major web browsers including Google Chrome, Mozilla Firefox and Internet Explorer. With the QNAP Surveillance Client for Mac, users can enjoy a similar experience on their Macs.

Advanced storage technology protection

Surveillance Station is installed on the Turbo vNAS platform and is protected against loss, theft, and damage of recorded videos with the help of advanced security features and RAID technology.

Live-view

Various remote monitoring modes

The Surveillance Station supports various monitoring modes to display up to 64 channels on a single screen. Users can also choose to sequentially display each channel or use dual displays for more information.

PTZ (Pan/Tilt/Zoom) control

On the Surveillance Station web interface, you can directly adjust the PTZ (Pan/Tilt/Zoom) functions of supported cameras, greatly enhancing the convenience in remote monitoring.

Instant playback

On the Live-view page, whenever you want to check suspicious events of a camera channel you just missed, just hit Instant Playback to bring up the window to review recent events.

Visual aid by E-map

Just upload pictures of monitored locations to the Surveillance Station and drag & drop the IP camera icons to them on the E-map. Once an alarm event happens, the camera icons will flash to indicate the event type for you to be immediately alerted to take necessary actions.

Instant notification

When alarm recording is enabled and an event occurs, an alarm icon will be instantly shown on the monitoring page. The alert details can be viewed by clicking the icon.



Please note: You can also use USB webcams for Surveillance Station to record videos. Just install the QUSBCam App on a TVS-ECx80+ from the QTS App Center to assist in building a small surveillance system for your office with USB webcams.

▶ Playback

Preview recordings by thumbnails

You can move the mouse cursor over the timeline to preview video thumbnails to quickly identify and search for events. No need to play the video from the start and wait.

Intelligent Video Analytics (IVA)

IVA is an advanced way to quickly search videos corresponding to particular modes, greatly saving the time & effort of manually screening out matching videos. IVA includes motion detection, foreign/missing objects, out-of-focus and camera occlusion.

Real-time watermarking

The support of digital watermarking assists in verifying the authenticity of exported videos and snapshots by showing the exact recording date & time, camera name, and Turbo vNAS model name, making it essential when videos are needed as verifiable evidence.

Playback and speed control by shuttle bar

With the speed control shuttle bar, you are able to fast forward playback by dragging the button to the right and to the left to rewind, helping you quickly find the desired screenshots.



▶ Flexible Management

Flexible camera access control

You can create up to 32 user accounts on the Surveillance Station and flexibly assign them to different user groups with different rights for monitoring, playback, PTZ control, and audio monitoring.

Advanced event management

The system starts alarm recording when alarm events occur. Administrators can configure events and assign 7 types of event actions to ensure that they are alerted immediately, including recording, PTZ Control, alarm output, email notification, SMS notification, buzzer notification, and user-defined actions.

Expendable license management

The Surveillance Station comes with at least one free IP camera license for each Turbo vNAS by default. Administrators can expand the channel number by purchasing additional licenses based on their demands. This provides a flexible and cost-effective method for scaling surveillance needs.

Manage large-scale camera

By connecting multiple Turbo vNAS units, you can simultaneously manage, monitor and playback up to 128 IP cameras with one Turbo vNAS. effective method for scaling surveillance needs.

▶ Mobile apps

VMobile – Surveillance at anytime, anywhere

VMobile allows you to monitor the Surveillance Station anytime, anywhere using iOS and Android devices. It provides camera live-view, PTZ control, instant event notifications, video snapshot, video playback, and searching videos by date and time.

Vcam – Turn your mobile device into a camera

Vcam turns your mobile device into a network camera. With the Vcam mobile app, you can record any moment around you to your Turbo vNAS, saving the need in buying expensive IP cameras.





3

Signage Station



The Signage Station is a free Turbo vNAS app that allows businesses to create attractive menu boards, advertising posters, and business profiles and easily publish them to monitors and tablet devices to attract more customers.

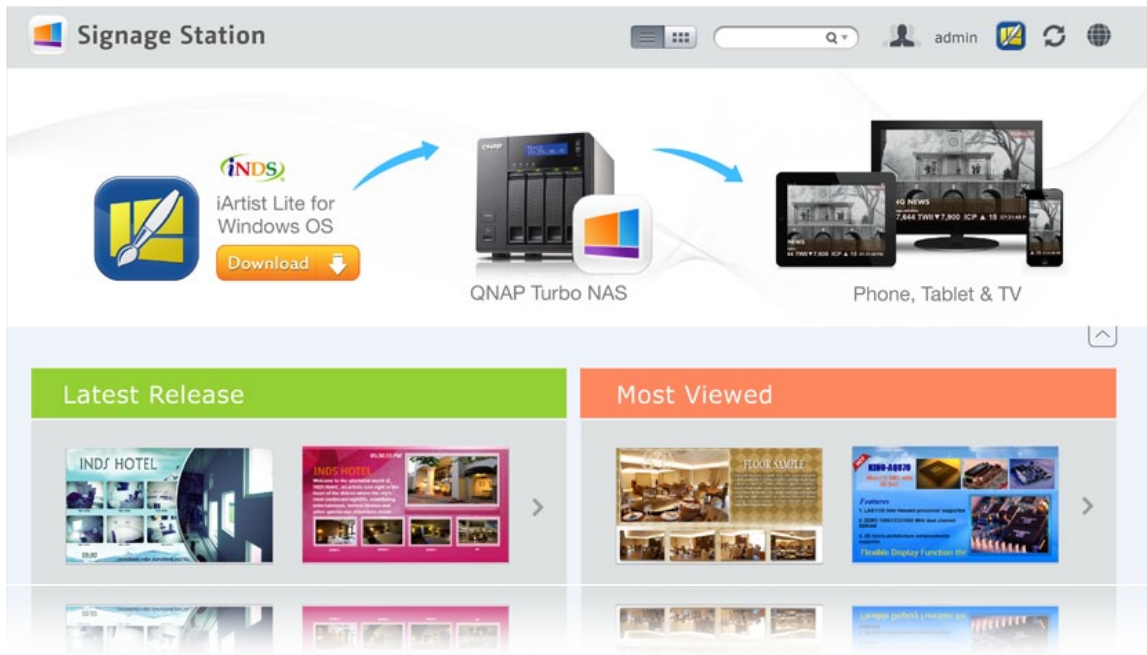

Drive business growth and increase revenue

Your content can be presented on a web browser and when on the go, and you can even show your profile, business card and product catalogs on mobile devices and share on Facebook. The Turbo vNAS with the Signage Station is an ideal tool to present creativity and drive business growth.

Absolutely easy-to-use

iArtist Lite provides a drag-and-drop interface that allows you to flexibly embed videos, marquees, pictures, and PowerPoint slides on the canvas panel. With the layered playlist and timeline features, you can freely arrange the order of media objects. iArtist Lite also offers numerous templates for various scenarios, saving you lots of time & effort. Useful widgets such as audio, clock, RSS are also available to add to the designed content.

Instantly publish and conveniently revise

With iArtist Lite you can save your designs as different projects and upload them to multiple Turbo vNAS with Signage Station installed. Whenever you want to revise the content, just open iArtist Lite to update and publish instantly. You can fully control all your content in a timely way.

Collaboration increasing efficiency

The original content can be saved on a local computer or the Turbo vNAS with the help of the connection wizard. Content saved on the Turbo vNAS is accessible for every authorized user to increase the work efficiency in projects involving multiple members.



iArtist Lite Create your advertising content easily

How to make advertising content on iArtist Lite?

The concept of dynamic multimedia content is quite simple: just drag & drop media files to the iArtist Lite canvas and arrange it as required. Choose the device that you want to display, such as tablet, HDTV or smartphone. After selecting the device resolution you can select whether to present it in portrait or landscape.

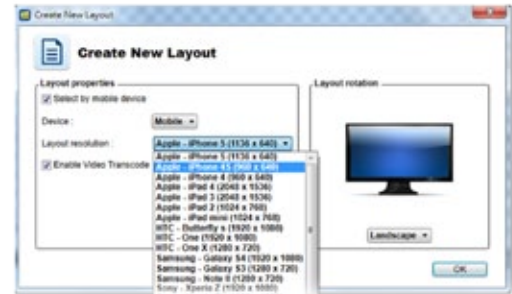

Introduction of iArtist Lite functions :

- | | |
|--------------------------------|----------------------------------|
| A Add new content | D Upload to Turbo vNAS |
| B Open previous content | E Preview design |
| C Save content | F Online template support |

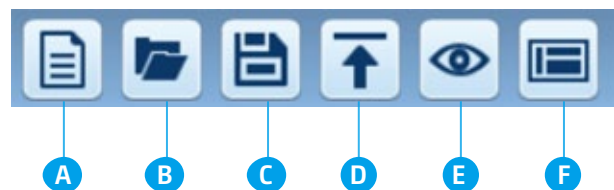

Introduction of iArtist Lite tools:

- **Video, photo, and music:** Add the file to the canvas from Windows.
- **Digital & analog clock:** Supports multiple types of clocks and formats, just drag & drop to canvas.
- **Background image:** Choose a background color or choose a background image.
- **Mask:** Add an image mask to the content.
- **Text & banner:** Edit the text on the banner you'd like to promote.
- **RSS:** Share an RSS link from a website to share messages.
- **Digital menu board:** Design a neat menu board, and edit the price and picture anytime, anywhere.
- **Combo menu board:** Select the template and add the price and picture.
- **HTML:** Drop a website on the canvas for the most direct promotion.
- **PPT and PDF:** Easily add documents to the canvas including slideshows, retaining the animations from the PPT.



Intuitive user interface with timeline view

After dragging & dropping from the left panel to the canvas, each media file will have a corresponding timeline at the bottom of the canvas to allow users to easily manage their timing and placement.



4 Notes Station 2.0



QNAP has now leveraged its private cloud functionality to introduce Notes Station 2.0. It provides the convenience of notetaking on cloud-based services but with the privacy and security of Turbo vNAS. Users do not have to worry about risks from public storage, and are able to enjoy easier data access at all times.



Single workspace for all notetaking activity

With its 3-level structure (Notebooks, Sections, and Notes), Notes Station 2.0 allows you to manage all your notes systematically and flexibly whether it is a note you write to yourself or for work. You can jot your valuable ideas in Notes Station 2.0 and keep them safely accessible through your own devices wherever you are.



Powerful editing

Notes Station 2.0 is capable of advanced editing. You can style the text by changing the size, font, or color. You can also edit inserted images with the built-in photo editor to enrich your content.

Google Calendar Support

The event in the Notes Station Calendar links to the note you created it from. You can update the calendar from Notes Station 2.0 to your Google Calendar with a single click, so you will be reminded for every event.

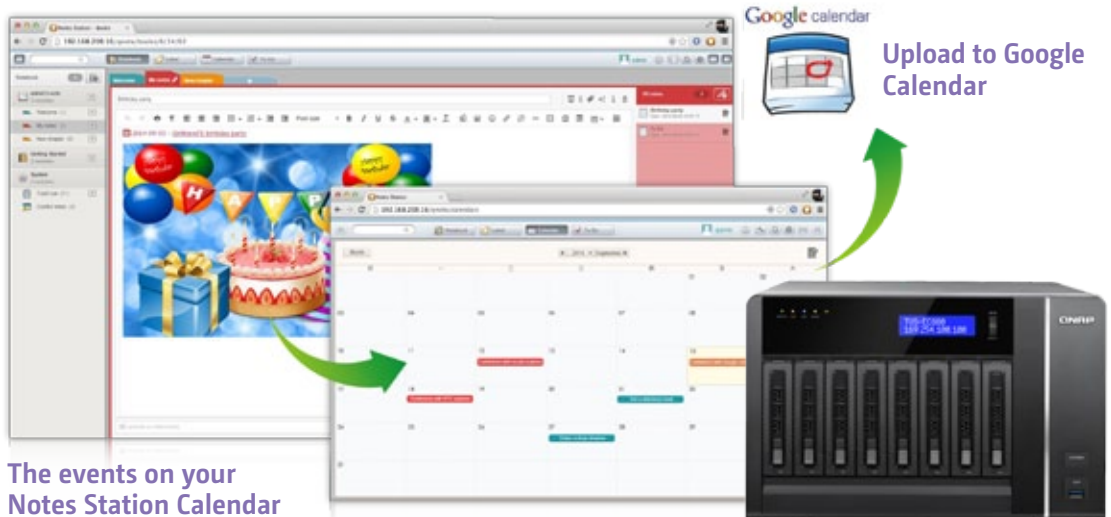

The events on your Notes Station Calendar

High-performance encryption

You can encrypt your notes with high-performance AES 256-bit encryption to protect against unauthorized access.



PDF import/export

Notes Station 2.0 can import PDF files into Notes Station 2.0, and export note files (i.e. Notes, Sections, Notebooks) to PDF files. When a notebook is exported, the sections and notes of the notebook transfer to the chapters and contents of a PDF file respectively, and vice versa for the import function.



Online preview

You can quickly view the attached files in PDF, Word or PowerPoint format online with Google Docs or Office Online. Other file formats such as photos, music and videos can be played instantly with the built-in programs.



RSS feeds import

If you have subscribed to RSS feeds from news websites or blogs, you can use Notes Station 2.0 to automatically import the published contents.



Notes sharing and collaboration

Notes Station 2.0 contributes to team work and networking. You can create a link for your notes and publish them on your social networks or share them through the apps on your smartphone. Thus, you can invite other people to work on the same notes.



Snapshot

You can use the snapshot function to back up different revisions of your notes. Your notes can be effortlessly restored to an earlier version. The QTS Snapshot is a great tool to record the state of a note at different time points. You can create up to 1,024 snapshots manually or by schedule and it is easy to retrieve files from a specific point in time if they are broken or mistakenly deleted.



Evernote backup

Notes Station 2.0 comes with an import function to restore backups from Evernote. In addition, you can directly access your notebooks in Evernote to import them online to Notes Station without exporting.





5 Backup Station



Protecting against potentially disastrous data loss is of paramount importance for all sizes of businesses from micro to enterprise. QNAP Turbo vNAS offers an all-inclusive backup and recovery solution with enormous storage capacity and superior transmission speed. With the functionalities in the Backup Station, data backup and recovery is simpler and more powerful regardless of your business's disaster recovery plan.

➤ All-inclusive data backup and disaster recovery

1. PC Backup

Windows users can install the free QNAP NetBak Replicator utility to back up files from Windows PC - entire disk drives, documents, pictures, music, videos, fonts, emails, and more - to one or multiple Turbo vNAS units. With simple clicks, you can set up real-time backup, scheduled backup and auto-backup. You can set power off after the backup is finished to save energy, file filtering to exclude files not to back up, and email notification when backup is completed.

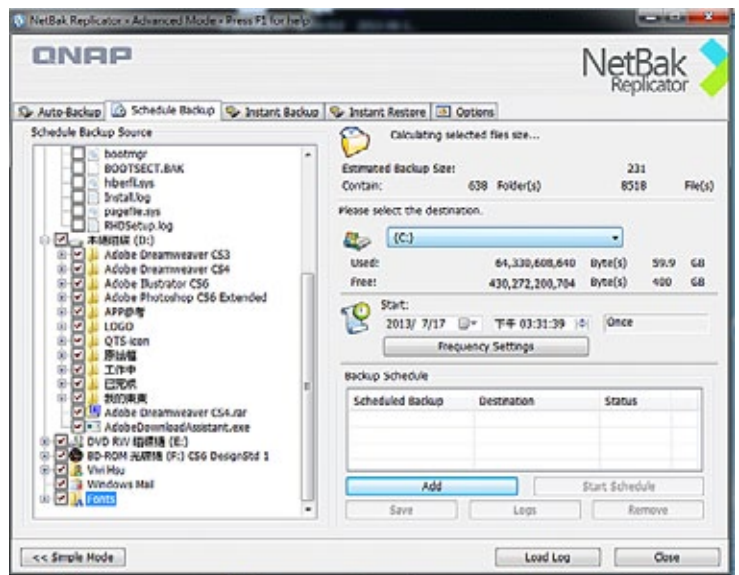

2. Mac Backup

Mac users can use the Mac Time Machine to back up data to the Turbo vNAS. You only need to set the Turbo vNAS as the backup destination on the Time Machine management page, and it's done.



➤ Back up data on the Turbo vNAS for disaster recovery

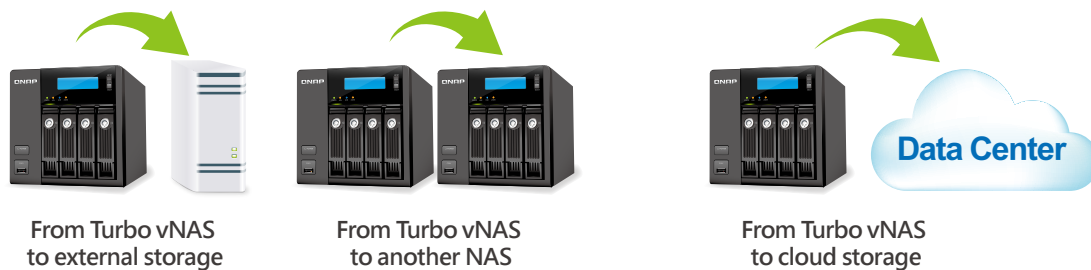

1. Local backup to external storage devices

Connect an USB device to one of the USB ports. Log into the QTS and go to "Control Panel">"Applications">"Backup Station" and create a job with the External Backup function.

2. Remote backup with RTRR/rsync services

- Use rsync protocol to execute scheduled backup to remote rsync server.
- Use RTRR (Real-Time Remote Replication) services for real time data backup to a remote Turbo vNAS or FTP server.
- Use RTRR to sync shared folders between two Turbo vNAS units.

3. Cloud backup to cloud storage

Users can back up the data from the Turbo vNAS to online cloud storage services, such as Amazon® S3, Amazon® Glacier, Microsoft® Azure, Google® Cloud Storage*, IBM® SoftLayer, HP® Cloud, Rackspace®, ElephantDrive®, hcloud S3, and CCIS. The Turbo vNAS also supports other types of cloud backup using S3, OpenStack Swift, WebDAV, or FTP service. Furthermore, Turbo vNAS provides advanced functions such as data encryption, compression, download/upload rate control and scheduled backup to suit your backup needs.

*Google® Cloud Storage will be available soon in the App Center for download.



Tap on the "Copy" button near the USB port on the front panel of the TVS-ECx80+ to instantly back up data to the Turbo vNAS.





Intuitive & Simple QTS 4.1.2 OS

Based on Linux, QTS 4.1.2 is designed to be simple and flexible while centralizing multiple applications efficiently in the App Center.

- Multi-Window:** Simultaneous multi-window operation for easy usage.
- Multi-Task:** Improve work efficiency by performing multiple tasks at the same time.
- Multi-Device:** Synchronize cross multiple devices anytime, anywhere.
- Multi-App:** Use a range of easy-to-manage apps and download more as needed.
- Multi-Scenario:** Customize your own cloud platform with multiple applications.

Intelligent Desktop

QTS 4.1.2's intelligent desktop offers an intuitive, sleek, and easy-to-follow graphic user interface that simplifies your Turbo vNAS experience. It allows you to open multiple application windows and simultaneously run multiple tasks. Application windows can be minimized to the toolbar to allow you to see an overview of the opened applications and switch between running applications.

Smart toolbar
 Displays all the active and scheduled tasks performed in the background.

External devices
 Access connected storage devices and safely eject them with a single click.

Event notifications
 Updates you with system information including warnings and other error messages.

Quick search
 Quickly search for system settings and QTS Help.

Main menu
 All of your applications, system preferences, and additional apps installed from the App Center are neatly presented for you to quickly find your desired app. Drag and drop frequently used icons to the desktop as shortcuts for easier access.

Multiple desktops
 The extended desktop workspace is specifically designed to improve your productivity. You can move apps to different desktops according to their category and freely switch between them.

Smart dashboard
 In just one click the smart dashboard presents all the important system information in a single panel. Drag any status to the desktop for constant monitoring.

Customized Login Page

Public photo wall and app shortcuts on the login page

Customize the photo wall based on your company image and display it on the login page. Each app has its own shortcut that you can place on the login page to allow direct access without the need to log into QTS first.

Enable this option and ...



Display the app shortcut on the login page.



Customized admin photo

Public photo wall

App shortcuts become available



NAS connection and network setting



Qfinder for connecting to a NAS

Instant connection and NAS setup

Qfinder is a utility for Windows, Mac, and Linux that lets you quickly find and access the Turbo vNAS over LAN. Install Qfinder on your computer, open it, and double click your Turbo vNAS name and the login page is ready for you.

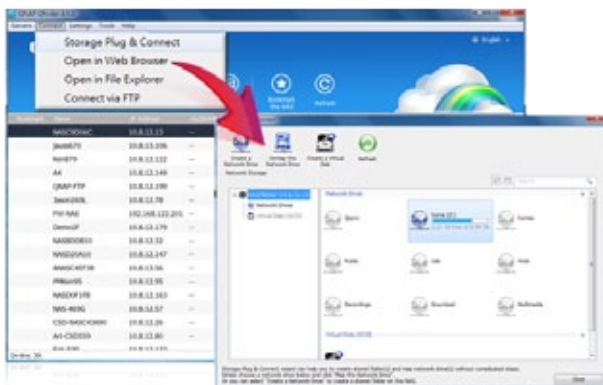
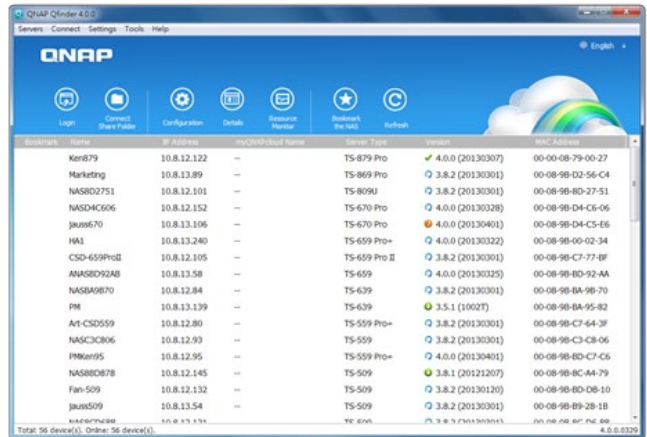

Easy access to NAS with Storage Plug & Connect

The Windows version of Qfinder provides a convenient way to connect to the Turbo vNAS and map a network drive or virtual disk. By creating a shared folder on the Turbo vNAS and mapping it as a network drive, you can use it as if it were a local drive on your computer.

System network setup

TCP / IP and service connection setup

TVS-ECx80+ offers 4 Gigabit LAN ports. You can click on the QTS [Control Panel] > [System Settings] > [Network] to activate service connection, assigning QTS applications to one or more network interfaces (over LAN or wireless). The NAS will allow application access based on IP sources to optimize the LAN ports utilization for your network environment.

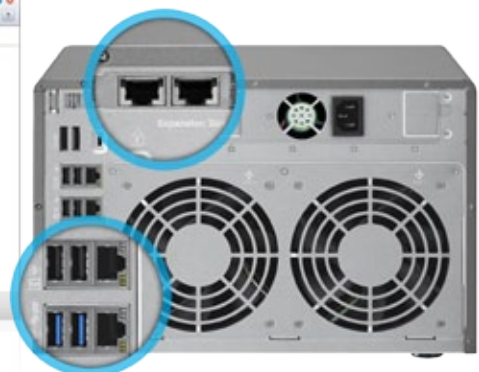
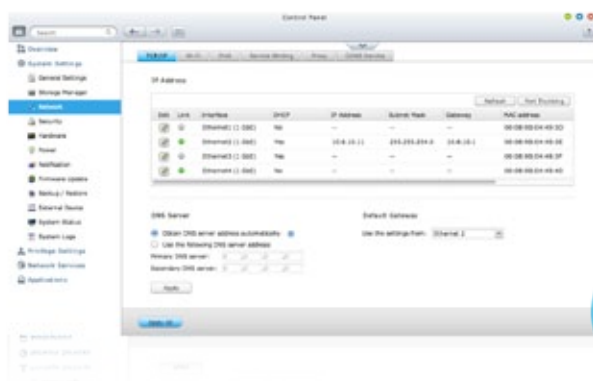

Optimize network resources with high security

TVS-ECx80+ offers 4 Gigabit LAN ports, and you can assign each port for different applications to optimize network resources and increase security (for example: Public IP, Intranet, Server Backend Network, VM Network, etc). When using Virtualization Station, the network traffic from the virtual machines (VMs) is isolated from the network used by the Turbo vNAS. The bandwidth for the Turbo vNAS applications will not be impacted by the VM operations, and the VMs can have dedicated bandwidth for operating high-traffic applications. Also, you can flexibly install LAN cards and arrange other LAN ports for different VMs to use as a dedicated network resource.

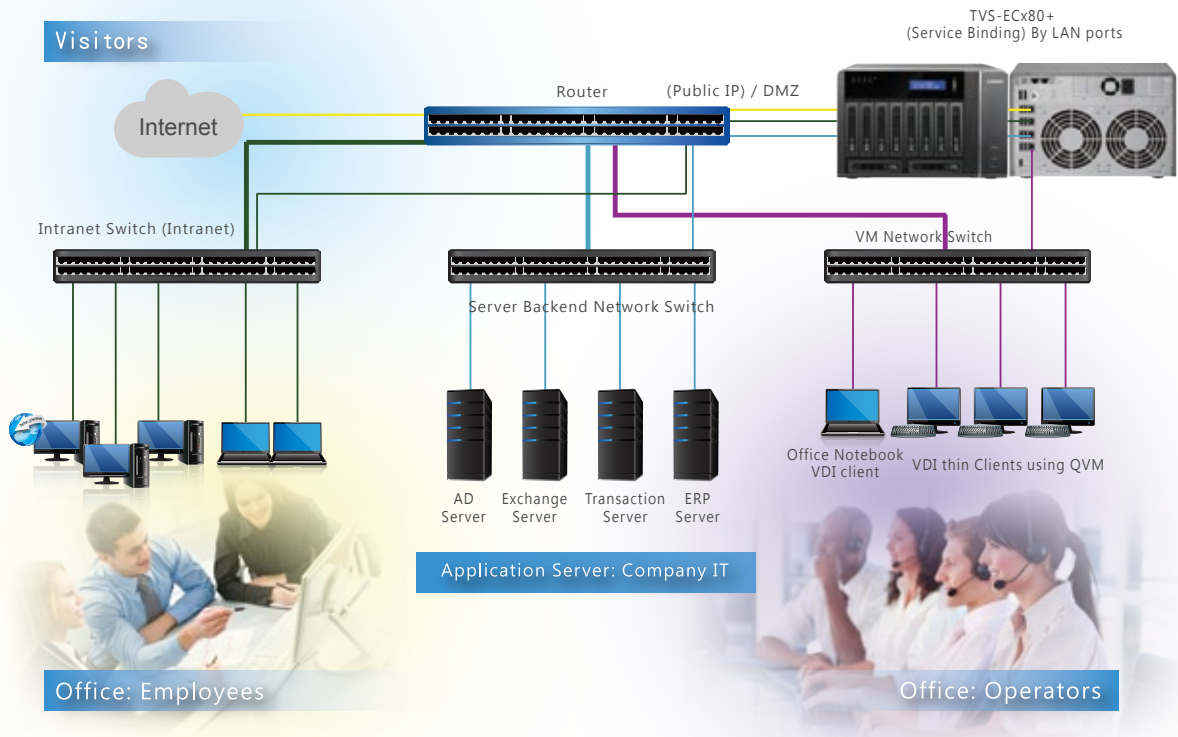

Port Trunking - Link Aggregation for high-speed and high-security file transmission

Including the practice mentioned above, 2 LAN ports can be used for Port Trunking - Link Aggregation, enabling IT administrators to set up link aggregation to increase total data transmission capabilities and achieve better efficiency for IT operations. Failover, load balancing, and multi-IP settings are also supported.

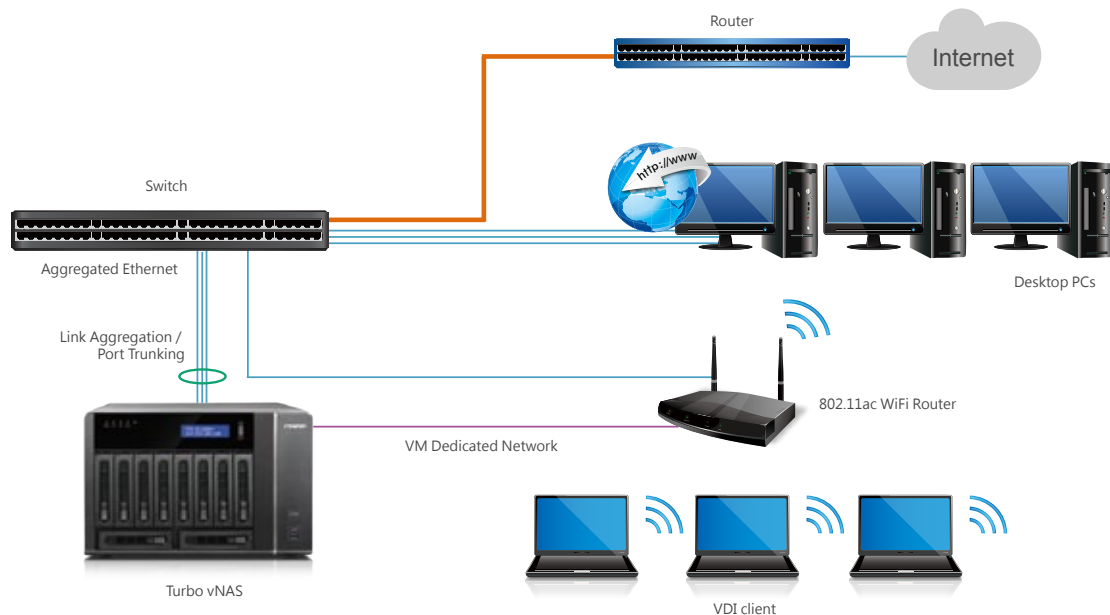



Wi-Fi network settings

TVS-ECx80+ supports Wi-Fi networks. Connect a USB Wi-Fi network card to the NAS, click QTS [Control Panel] > [System Settings] > [Network] > [Wi-Fi], and the available Wi-Fi access points will be listed. The QTS 4.1.2 supports 802.11ac Wi-Fi network protocols. You can connect the TVS-ECx80+ to a router supporting 802.11ac protocols for higher file transfer speeds.

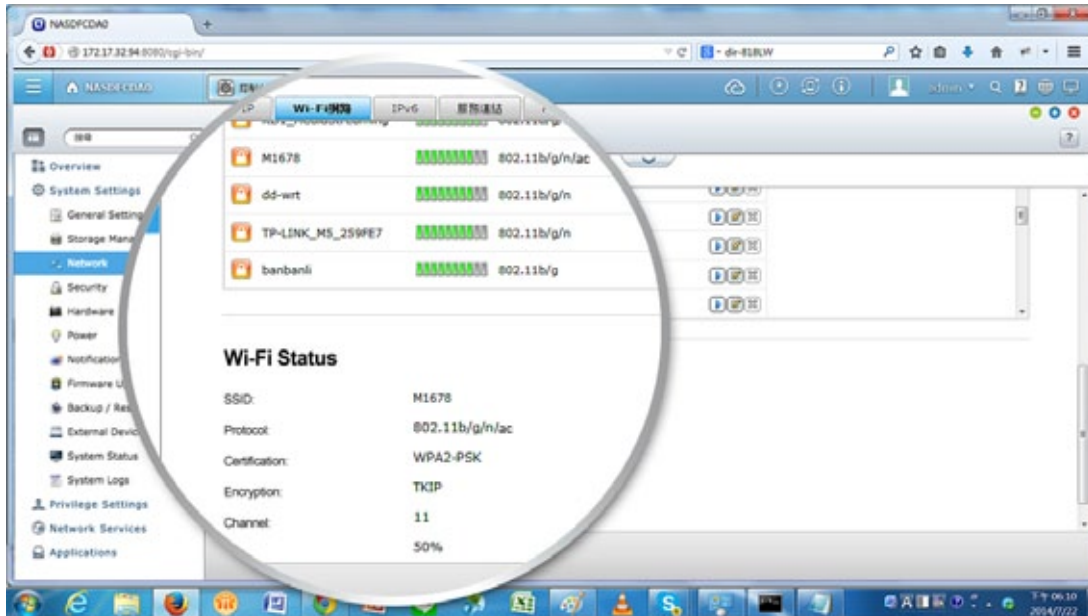

A Turbo vNAS can support a USB Wi-Fi network card. Visit www.qnap.com for a full Wi-Fi network card compatibility list.

Dynamic DNS (DDNS) service

After connecting to the Internet, click [Control Panel] > [System Settings] > [Network] > [DDNS Service] to get the Internet IP address. The IP address can be a DHCP or a fixed address according to your Internet Service Provider (ISP). You can use the IP address and register a DDNS on a DDNS server. By properly setting up DDNS, the Turbo vNAS ensures that it is always reachable by automatically updating its IP address with the DDNS service provider whenever the IP address changes.

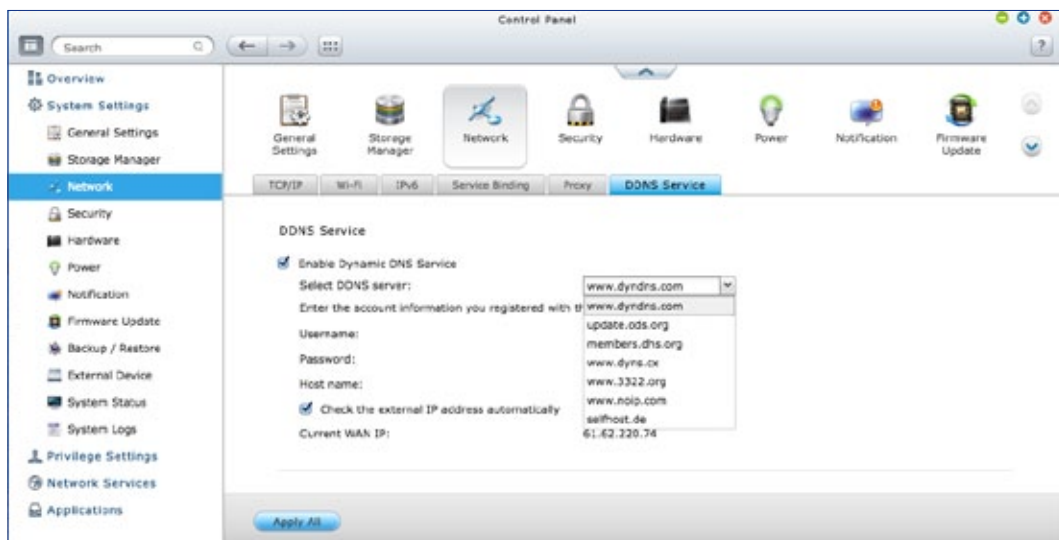

Application Server

QTS 4.1.2 integrates numerous server functions, including Web Server and Printer Server.

Web Server

QTS has a built-in Web Server with PHP/MySQL support and allows hosting multiple websites and running web applications on the Turbo vNAS such as Joomla, phpBB, and other online marketing platforms.



FTP Server

Large file sharing

Use FTP for high-speed data transfer and increase the efficiency of large file sharing.

Flexible settings

Use anonymous login, read/write, read-only control or bandwidth control to flexibly manage the access right control.

Secure access

Use the safe FTPS (FTP over SSL/TLS) connection to ensure secure data transmission.

Printer Server

QTS supports Printer Server, with the support for IPP (Internet Printing Protocol), Samba, print job management, and Bonjour printing on Mac OS X. By connecting a compatible USB printer to the Turbo vNAS, members can instantly share the printer resources over the network at the same time (Max. 3 USB printers).





Security Management

QTS offers various security management options to protect the system from hacking and data from interception, theft, and loss. QTS security management meets the electronic requirements of HIPAA (Health Insurance Portability and Accountability Act), performing as an ideal storage solution to store medical records.

➤ Privilege settings

Windows AD/ACL

QTS supports Windows AD/ACL to help IT administrators manage user account more effectively, and to simplify the process of privilege settings in large-scale organizations. QTS also supports SAMBA v4 that enables the Turbo vNAS to serve as a Windows domain controller to manage privilege settings.

LDAP Directory Service

QTS supports the LDAP protocol, integrating the Turbo vNAS into networks that have deployed an LDAP-based directory service such as OpenLDAP and greatly simplifying the efforts of managing a large amount of user accounts. QTS makes Turbo vNAS a LDAP server too.

RADIUS Server

QTS RADIUS Server provides centralized authentication and authorization management for computers to connect and use a network service. The QTS RADIUS Server maintains a list of user accounts that are authorized for remote network access through dial-up equipment, Wi-Fi access point, or VPN connections. IT administrators can easily apply access policies to multiple access points for a fine-grained control of network access.



➤ Anti-hacking

IP blocking

IT administrators can set up the black and white lists to grant proper access from different users to the Turbo vNAS by IP address. It operates as a policy-based automatic IP blocking by enabling the network access protection command.



➤ Anti-theft

Hard drive encryption

QTS supports up to AES 256-bit encryption for internal drives and external USB/eSATA drives, and adopts a military-level FIPS 140-2 validated encryption, which is considered to be the highest security certification for compliance.

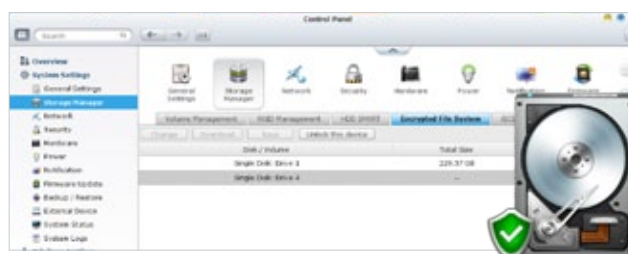

➤ Anti-virus

QTS integrates the ClamAV antivirus toolkit to defend against the latest viruses, malware, worms, and Trojan horses with continuous free virus database updates, ensuring continuous business operation. An email notification upon task completion or virus detection is provided. QTS also supports McAfee virus scanner which is available in the QTS App Center with a free 30-day trial.

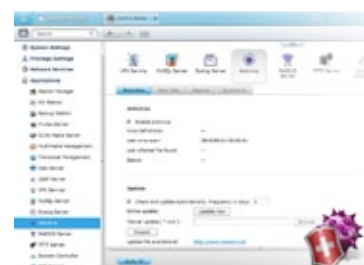

▶ Anti-interception

VPN Server

QTS supports VPN Server, with VPN connections secured with up to 256-bit encryption. It is easy to configure and is seamlessly integrated with the QNAP myQNAPcloud service and Auto Router Configuration. Complicated port forwarding settings for PPTP and OpenVPN are therefore simplified.

Encrypted access

QTS supports SSL, SSH and SFTP for secure connection and data transfer. IT administrators can host websites on the Turbo vNAS and only allow access via HTTPS (SSL over HTTP) secure channel.

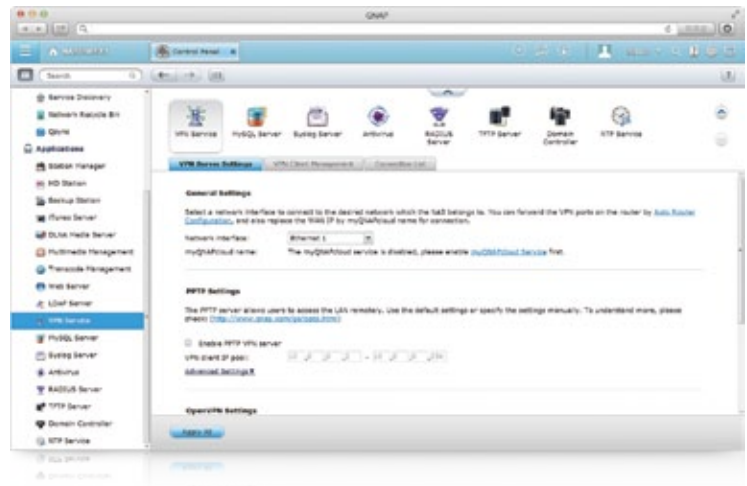

The best solution for secured communication –VPN + proxy server

▶ VPN

Virtual private network (VPN) offers secure connections to access network resources and services across a public network. VPN offers a convenient solution for NAS users to build end-to-end encrypted tunnels to your Turbo vNAS. The built-in VPN functions in the Turbo vNAS supports two different configurations: a client-to-site VPN, which allows clients to securely connect back to the NAS, and a server-to-server VPN, which allows a Turbo vNAS to connect to another Turbo vNAS across a WAN. In the client-to-server VPN configuration, employees or users can access enterprise IT resources remotely through their mobile devices such as smartphones and tablets. Furthermore, they can also access websites that may be blocked in your network environment through the VPN service.

Turbo vNAS as a VPN Server

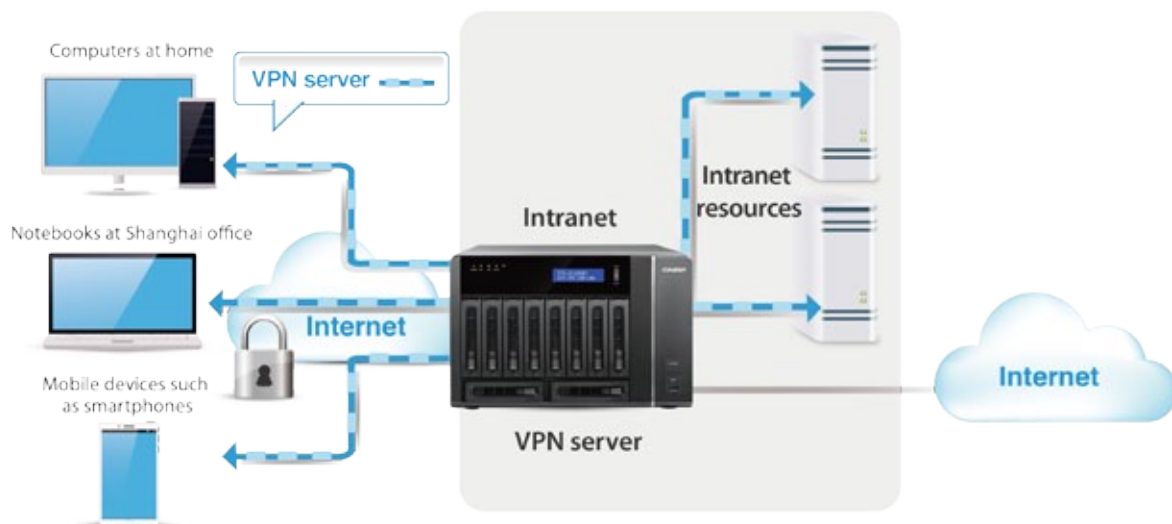



In the server-to-server VPN configuration, VPN can better protect your data when you use services like BitTorrent and eMule). By using this type of configuration, you can set up remote site backup with secure data transmission.

Turbo vNAS As a VPN Client for File Download

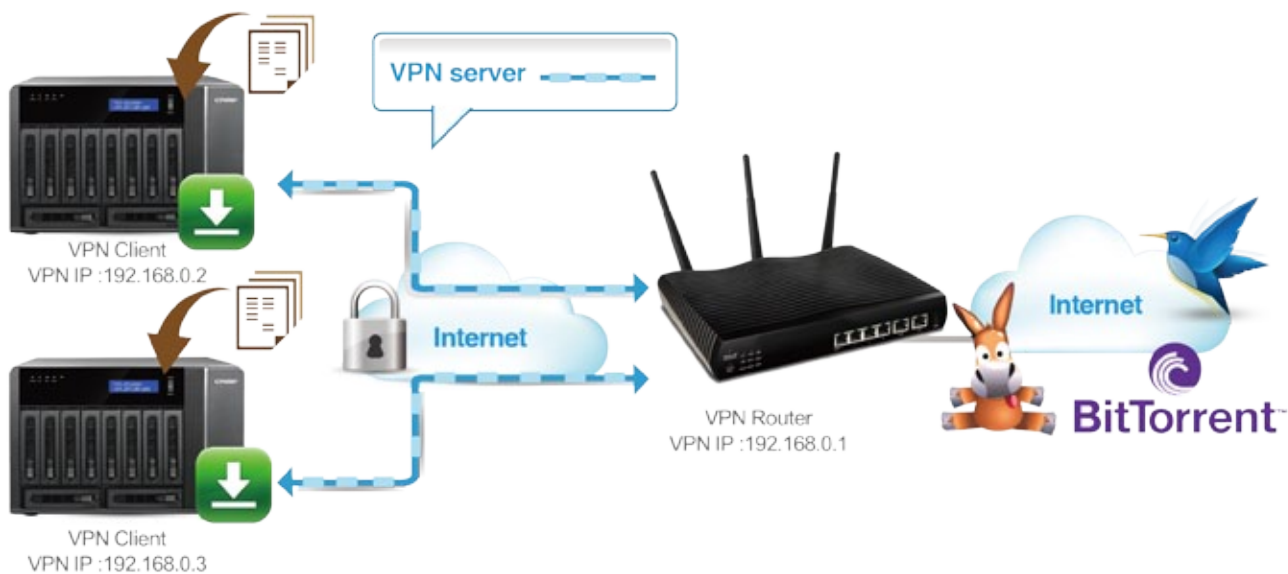

Turbo vNAS as a VPN Client for Off-site Backup

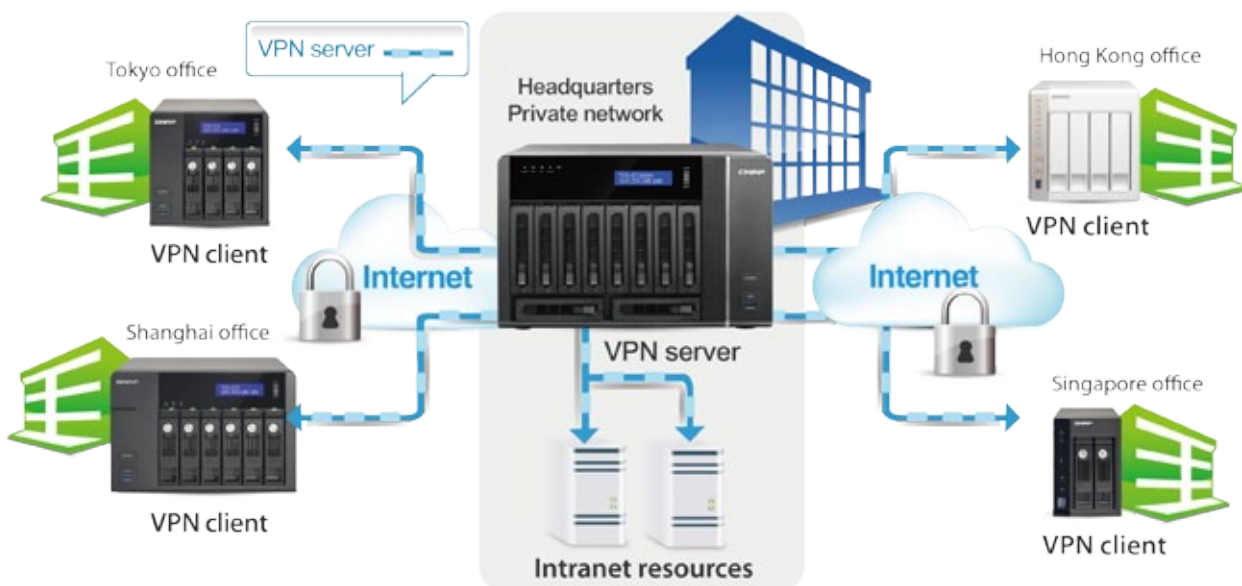

➤ Squid: the popular web proxy server

The web proxy provides cache and connection control for internet services like HTTP, FTP. For companies that need a boost to web response time and security, Squid can be leveraged to make your Turbo vNAS a web proxy server to protect other devices in your local network from internet attacks.

Caching: Improves response times and saves bandwidth required for web access by caching visited web content and other web resources.

Access control: blocks access to certain websites or restricts access for internet connections.

Logging: logs visits to web sites for generating statistics to aid in network management.

Load balancing: distributes the load to several web servers to accelerate service requests.

Turbo vNAS as a Proxy Server for Access Control

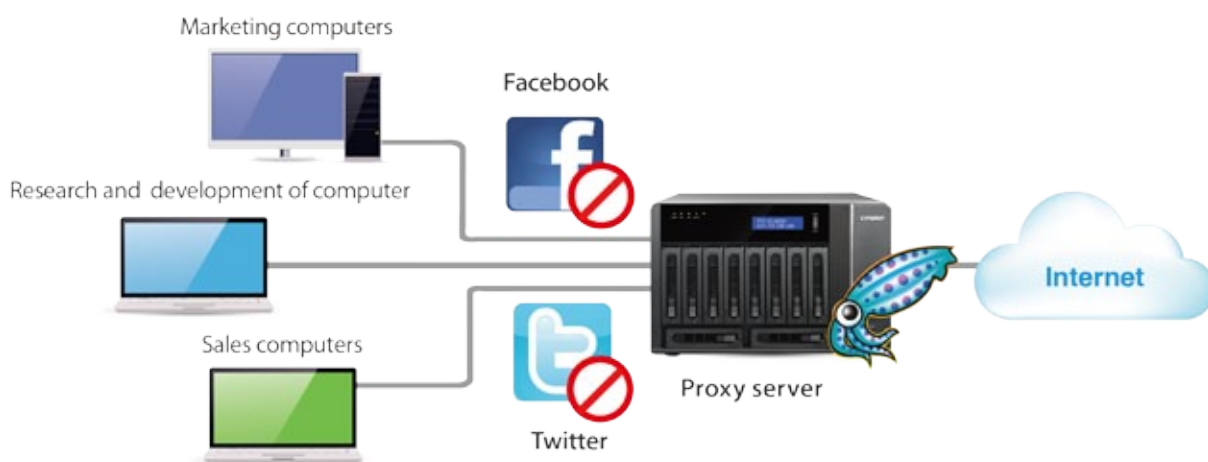

Case study for VPN + proxy services

Company X decided to open an overseas branch to expand its sales. In a fast-paced, competitive business environment, it is more important than ever to keep your employees connected to the people and resources they work with every day. Hence, the management team of this company required using networking technology to reach this goal.

The IT personnel of Company X found that a QNAP Turbo vNAS is easy to set up and use. It not only provides everything needed for a data storage, but also offers VPN and web proxy services for network access to employees in the main office, as well as home and branch offices. Furthermore, the consumption of bandwidth is minimized while improving the web access experience by using the web proxy function offered by Squid on the Turbo vNAS.

Now, the employees of Company X enjoy secure, high-speed connectivity to the Internet and their business networks—both inside and outside the office to efficiently retrieve product information as soon as it is announced. And the IT personnel rely on the scheduled backup from branch offices to the main office for peace of mind.

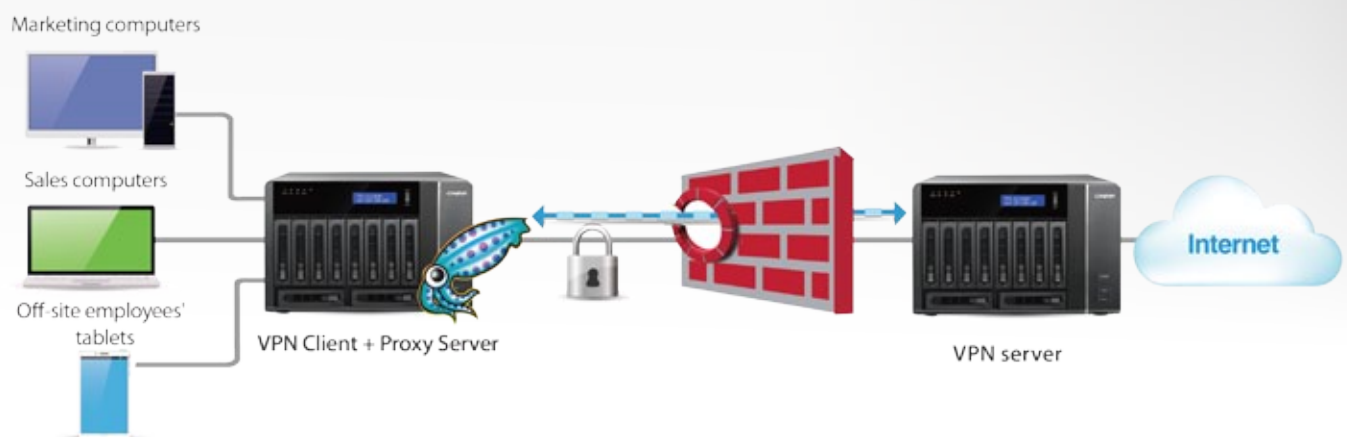



Uninterruptible Power Supply (UPS)

Activate the UPS support to ensure the Turbo vNAS is properly shut down if power fails. In the event of a power failure the Turbo vNAS will shut down automatically or enter auto-protection mode by probing the power status of the connected UPS unit. You can set up the function by clicking QTS [Control Panel] > [System Settings] > [External Device] > [UPS].

➤ Case study for NAS connecting to a USB UPS

You can set the Turbo vNAS to shut down or enter auto-protection mode if the power fails, and determine the action after few minutes of the power failure. Once the auto-protection mode is activated, the Turbo vNAS will revert to the state before power failure and continue to operate when the power restores.

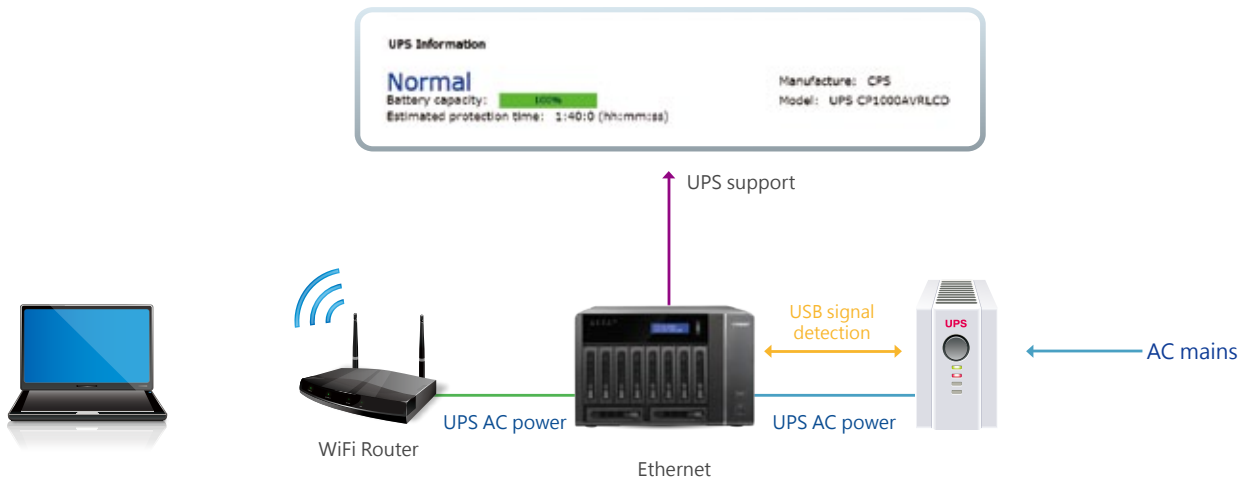

➤ UPS with SNMP management

When the Turbo vNAS and the SNMP-based UPS server connect to the same network, you can select [SNMP connection] and enter the IP address of SNMP UPS server to set up the power failure notification.

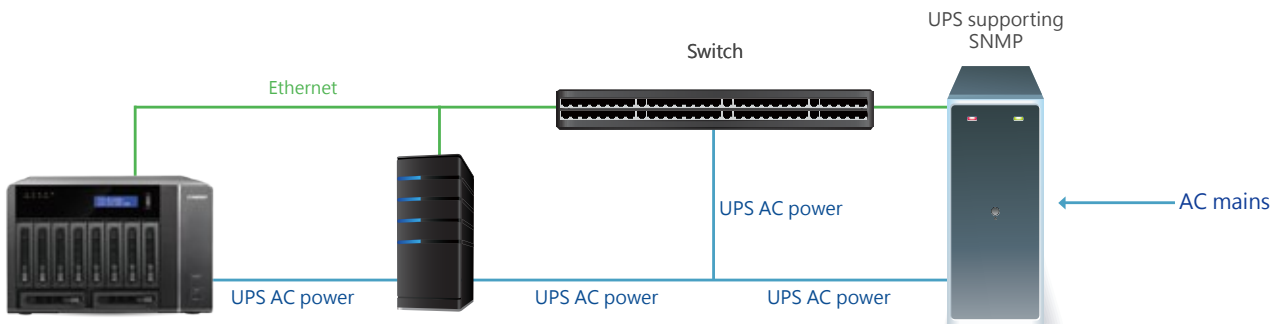

Multiple NAS units share USB UPS

The network UPS "master" is connected to the UPS via USB cable. If the power fails, the UPS sends a notification to the network UPS "master" via USB and all the UPS "slaves" are informed by the UPS master via Ethernet. To set your Turbo vNAS as a UPS "slave": connect the UPS and the Turbo vNAS by USB, select [NetworkUPS slave], enter the IP address of the master server, so the slave server will get notification when the power fails.

Step 2:
Enter the IP address of the master server

Step 1:
Select "Network UPS slave"

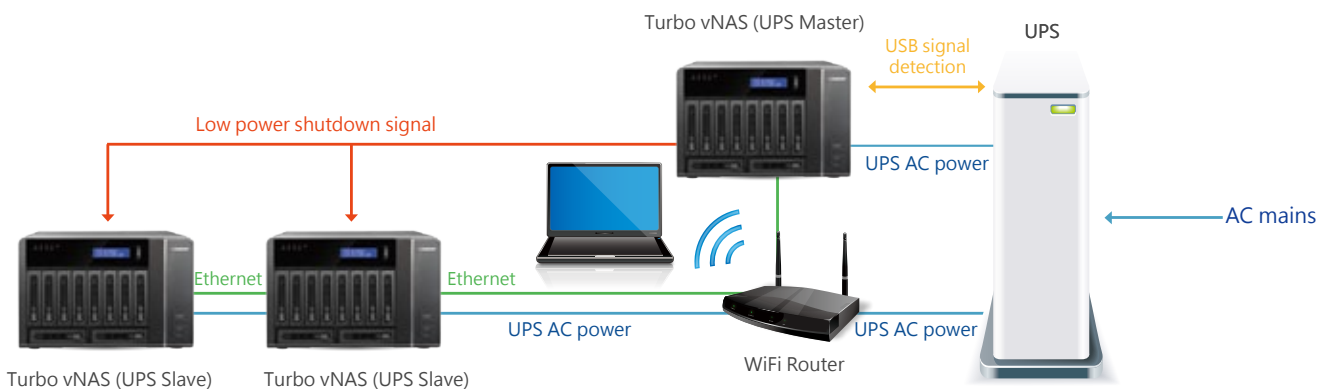
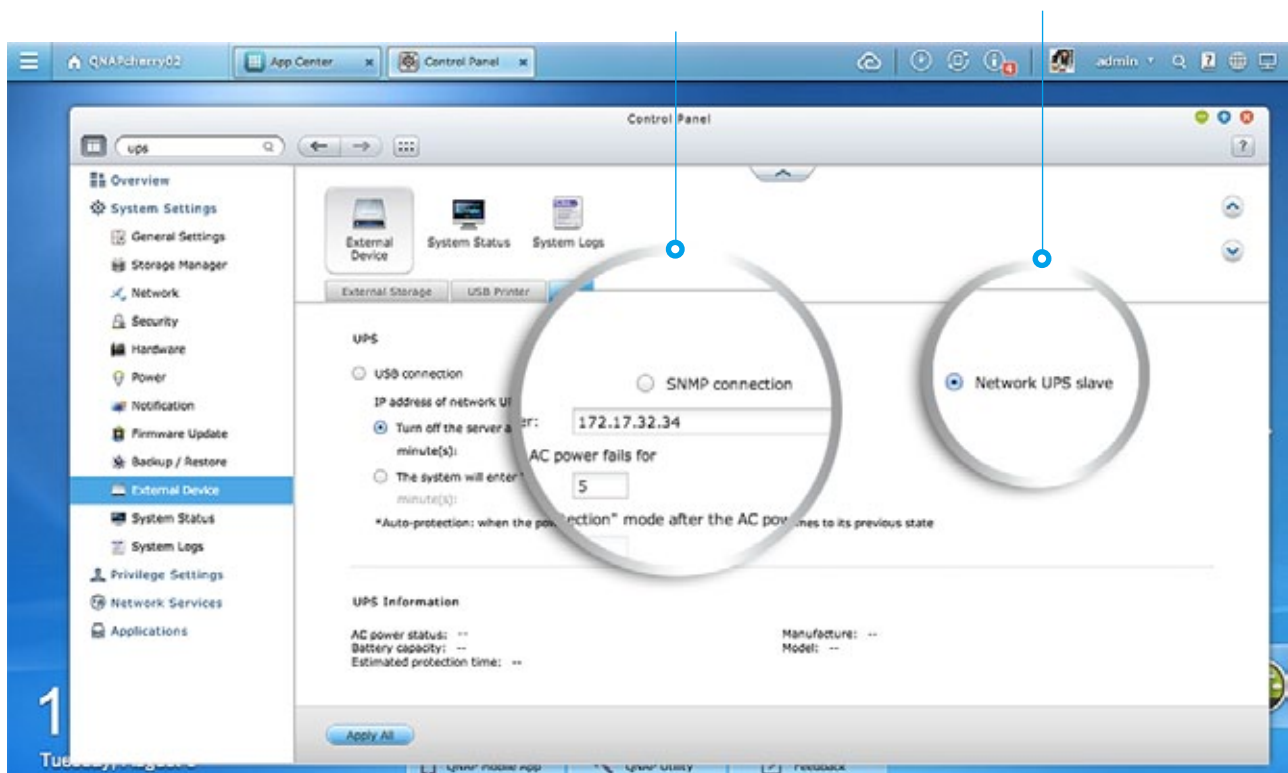



myQNAPcloud SmartLink



myQNAPcloud connection

With the myQNAPcloud service it's easy to create a personal/private cloud for enjoying your Turbo vNAS services safely and conveniently.

myQNAPcloud ID (QID)

Access your Turbo vNAS by signing into your myQNAPcloud portal (www.myqnapcloud.com) with your "QID": a unique ID for you to access your Turbo vNAS and securely share your private data and files.

Publish and share

myQNAPcloud is an easy-to-setup service that simplifies the steps in publishing Turbo vNAS content over the Internet. On QTS myQNAPcloud, you can select numerous web-based Turbo vNAS services, such as Photo Station, Music Station, and File Station to be published to the myQNAPcloud.com website. Likewise, you can easily view friends' public services on the myQNAPcloud.com website too.

Web-based file management

The myQNAPcloud portal enables you to manage multiple Turbo vNAS units in one place. With the easy-to-use management interface, you can simply download, move, and copy files on your Turbo vNAS, lessening the difficulty in accessing multiple Turbo vNAS servers. All you need is to sign into myQNAPcloud.

Trustworthy file protection

To ensure the security of remote access service, myQNAPcloud strengthens keys on SSL Certificates to 2048-bits. The files on the Turbo vNAS are 100% under the NAS owner's control.



myQNAPcloud Connect

myQNAPcloud Connect application is designed for Windows PC users. By installing the myQNAPcloud Connect, users are able to connect to the Turbo vNAS and easily manage files by dragging-and-dropping within Windows Explorer.





CloudLink for easy remote access

myQNAPcloud features the new CloudLink App (QPKG) for an easier remote access experience. Without any complex router settings, all you need to do is install the app and login with your myQNAPcloud ID (QID), then you can access to your Turbo vNAS through the myQNAPcloud.com website. CloudLink will automatically choose the best way to connect based on your network environment. CloudLink supports access to the Turbo vNAS via mobile devices with the Qfile/Qmanager apps or via computer with the Qsync utility. Visit the QNAP App Center to download the CloudLink App (QPKG), and experience the new myQNAPcloud Smart Link remote access service.

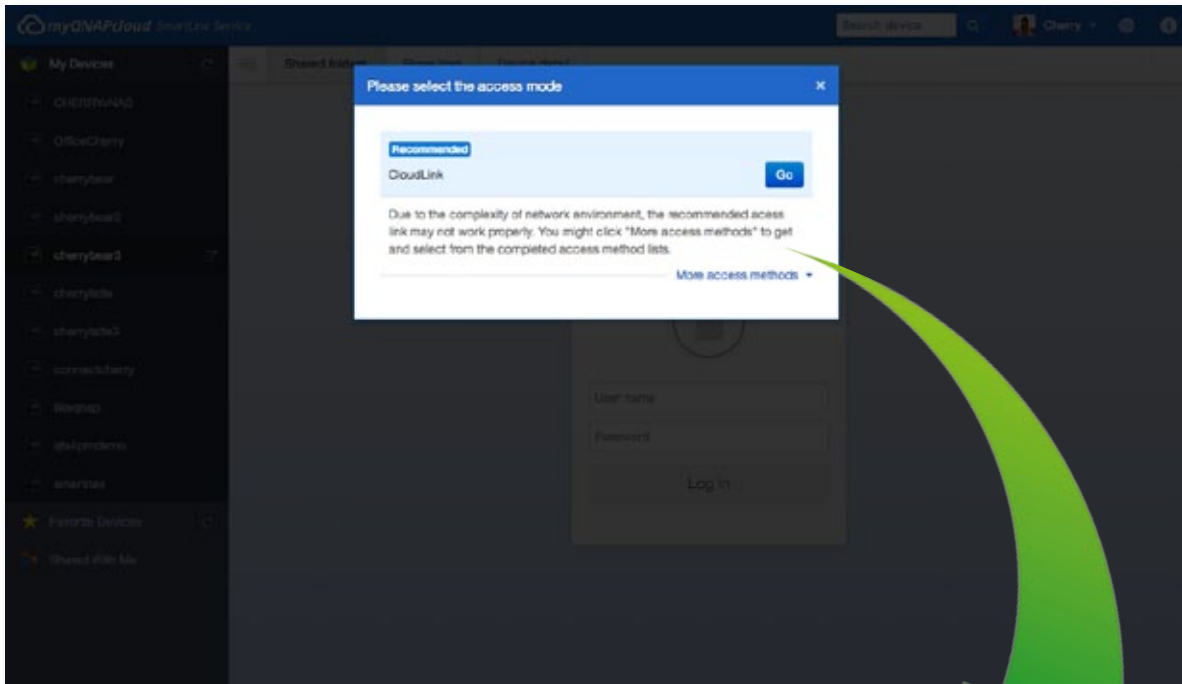

Please note: the CloudLink App (QPKG) requires firmware v. 4.1.0 or newer.



Please note: the CloudLink App (QPKG) requires firmware v. 4.1.0 or newer.



Qsync: A Powerful Utility for File Synchronization in Business & Personal Applications.

Public cloud files synchronization services such as Dropbox can greatly increase the efficiency and productivity of offices, but comes with certain drawbacks:

1. Security: there is the possibility of data leaks and interception of confidential information.
2. Cost: the greater the size of your data storage needs, the greater the cost of the service.



With QNAP's Qsync utility on Turbo vNAS, IT administrators can create a Dropbox-like private cloud with a larger storage capacity to fulfill business needs. Any files added to the Qsync folder will be automatically accessible across multiple devices linked to the Turbo vNAS, and synchronized with different work groups flexibly and effortlessly. With no additional costs or storage limits, Qsync can centralize files from different work groups and assist in teamwork on important projects anytime, anywhere.

7 reasons why you need Qsync

1. Cross-device synchronization

Qsync turns your Turbo vNAS into a safe data center for files synchronization. Every file uploaded to the Qsync folder will be made available to multiple devices including computers, laptops and mobile devices. When you are away on a business trip, Qsync ensures that the most up-to-date files are accessible on all linked devices and reduces your need to rely on USB storage to carry files and on emails to get the latest files.

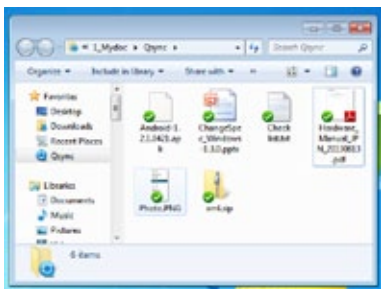

Synchronize with Windows

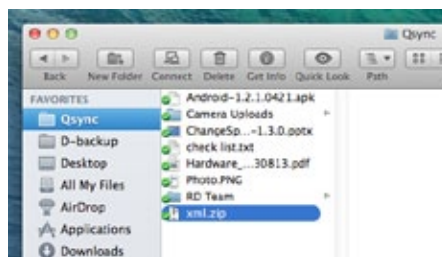

Synchronize with Mac

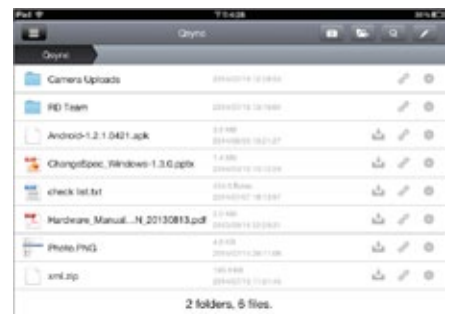

Synchronize with iPhone/Android smartphones via Qfile. Synchronize with iPad via Qfile HD

2. Intelligent offline editing

You can edit your files offline and once your device is online, Qsync will automatically sync them. This offline editing feature ensures your files are protected without any information loss.

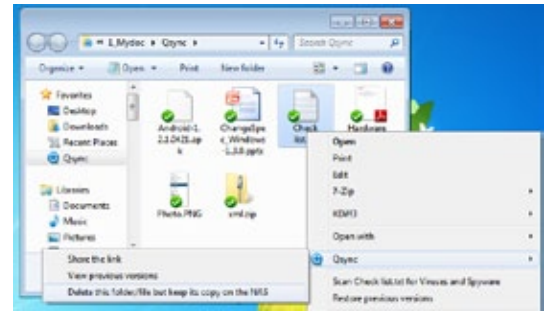

3. Flexible synchronization methods

Qsync has many sync settings to prevent taking up significant storage space on your computer. With both Full Sync and Smart Sync options, you can choose to synchronize all the files in the Qsync folder or you can enable the Smart Sync option to remove local files without affecting the centralized files stored on your Turbo vNAS.

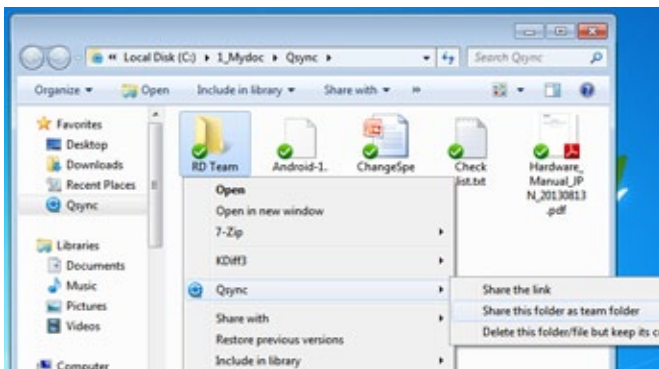
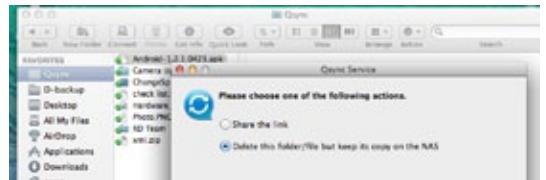

4. Share files & folders more efficiently

You can create sub-folders within the Qsync folder, share each with different work groups and everyone with the same sub-folder is always kept up-to-date with the latest files. All your files are shared via drag-and-drop. With Qsync, your Turbo vNAS becomes an aggregative data center and greatly enhances teamwork flexibility.

5. Auto-upload from mobile devices

You can enable the auto-upload option on the Qfile mobile app and automatically sync your files to multiple devices. Your meeting minutes, notes, and seminar recaps will be automatically uploaded and synchronized as well.

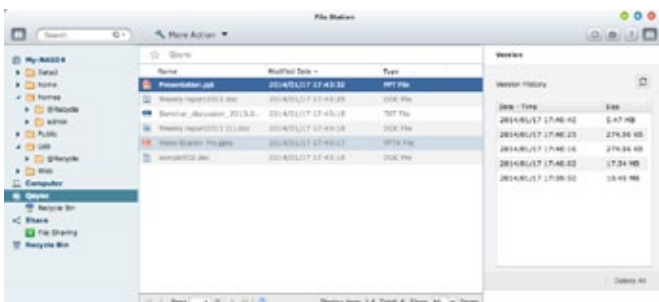

6. Integrated version controls protect against accidental deletion

The Turbo vNAS will retain up to 64 versions of files when they are modified, allowing you to retrieve a specific previous version at any time. Even if you have accidentally deleted the file you can restore previous versions from the recycle bin. With capacity-efficient restoration, the reserved version only keeps the changes made to the file and assists in optimizing your storage space.

7. High security

Qsync can create a private cloud within your intranet and benefit from your existing secure network environment. The Turbo vNAS also supports HTTPS connection assisting in creating a safer, more reliable business network environment.



Share files with mobile devices

You can install the QNAP apps on your mobile device to browse and manage files stored on your Turbo vNAS anytime, anywhere.



Qfile

Access from anywhere

Open Qfile on your mobile device to browse files on the Turbo vNAS. You can open or share files, and easily rename, copy, move and download any selected files.

Stream multimedia contents

Browse and play the music, photos and videos on the Turbo vNAS. No more worries about the space limitation of your mobile device.

Auto-upload photos

Automatically upload photos to your Turbo vNAS whenever you take new photos. It works as a real-time backup of your precious photos.

Offline file reading

Download documents, photos or music from the Turbo vNAS to your mobile devices for offline reading.

Folder & file sharing

Create download links for shared folders or files and share via email or SMS. You can also share by email as attachments.



Vmobile

Mobile surveillance with ease

Vmobile is a professional surveillance mobile app for remotely managing the Surveillance Station of linked Turbo vNAS or the IP cameras of VioStor NVR.

More advanced functions

Besides real-time monitoring, the Vmobile allows you to remotely control the recording, snapshots, and playback. Once alarm events occur, an instant notification is also provided.



Qmanager

Manage multiple NAS units

Add multiple Turbo vNAS units on Qmanager, and conveniently manage anyone of them anytime and anywhere.

Monitor system status

Monitor your system information, such as CPU usage, memory usage, system event information, online users, etc. You can also check connection status to prevent suspicious invasion.

Remotely manage

With one click, you can use Qmanager to turn on/off or restart the Turbo vNAS, open or close Turbo vNAS services, and set up Wake on LAN.



Utilities

Work efficiently and manage the Turbo vNAS smartly with the various easy-to-use and practical utilities.

Qfinder

Qfinder is available for Windows, Mac, and Linux users to quickly find and access the Turbo vNAS over the LAN. You can also update the firmware or set up Wake on LAN through the Qfinder.

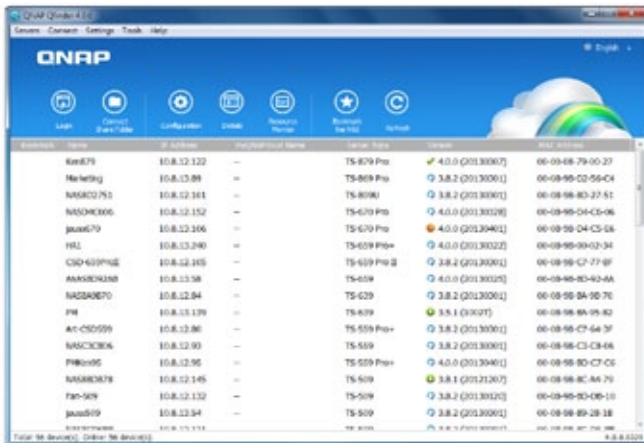

myQNAPcloud Connect

myQNAPcloud Connect is designed for Windows PC users to connect to the Turbo vNAS and easily manage files by drag-and-drop within the Windows Explorer.



Qsync

Qsync provides cross-platform synchronization. It creates a specific "Qsync folder" in your devices that you can simply drop files in, and synchronizes the files to all your devices linked to the Turbo vNAS.



NetBak Replicator

QNAP NetBak Replicator helps you easily back up files or the entire hard drive data from Windows PC to the Turbo vNAS. It also supports backing up to a remote server via FTP and WebDAV through the Internet.

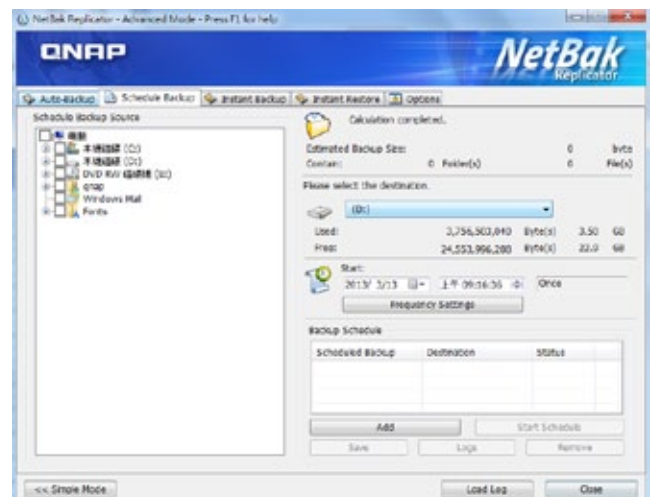



App Center & Development Platform

The QTS App Center provides various apps for you to install on demand, enjoy more applications and increase the value of your purchase.

Powerful and packed with features

The App Center provides over 100 apps, including backup/sync, business, content management, communications, developer tools, download, entertainment, surveillance, utilities and more.

Install in demand

Find what you need and install it immediately with just one click.



Upgrade reminder

If newer versions of your installed apps are available, an upgrade reminder will show on the QTS desktop to help you keep your Turbo vNAS applications up-to-date.



Gmail Backup

Gmail backup provides Gmail backup and recovery functionality, allowing users to create individual backup or domain account backup tasks. Gmail can be backed up by schedule and the content previewed through a web management interface. Backed up mail can be restored to the original mail account or other accounts: just configure the restore account, enter the account and password and the user can restore mail to the specified account.



Google Drive Sync App

Google Drive is a cloud storage service provided by Google that lets users save their files online for accessing them anywhere. By installing the Google Drive Sync QPKG on your Turbo vNAS you can select a shared folder to synchronize data with Google Drive or simply use Google Drive as a backup destination.





Dropbox App

The Dropbox service is a cloud-based storage service that allows you to access your photos, documents, and videos anywhere, anytime with easy sharing. However, the free space from the Dropbox service is limited. To make it more efficient you can connect it with your Turbo vNAS to store files.



How to use the Dropbox App?

The QNAP Dropbox app can synchronize your Dropbox account and your Dropbox folder on the Turbo vNAS in both directions and in real-time. After you install the Dropbox QPKG and log into your Dropbox account, a Turbo vNAS folder called "home" will be created and the synchronization process will start. With Real Time Remote Replication (RTRR), a built-in Turbo vNAS function, you can easily back up files from your Dropbox account.

The following multimedia applications are disabled by default on TVS-ECx80+ to conserve system resources. To enable them, go to "Control Panel" > "General Settings" > "System Administration."



Video Station

Build a corporate video website

Video Station is great for archiving and playing video collections online. Just upload videos, and the Video Station will smoothly play the video with an optimized resolution for your device and bandwidth.

Easy video sorting

You can easily categorize your videos as company videos, movies, TV shows, and music videos for greater organization.

Smart collection

Create a smart video collection that matches predefined criteria for names and ratings, making it easier to find the videos you want to watch.

Easy video sharing

Share your videos with friends & family via email, download link or social networking sites including Facebook, Google+ and Twitter.





Music Station

Organize huge music collections

Browse your music in multiple ways, create up to 200 playlists, and rate your music to feature it in a "My Favorites" collection.

Cloud music center

Access the Music Station via the Internet to enjoy your entire music collection from anywhere on any device.

Listen to thousands of Internet radio stations

With the built-in TuneIn radio, you can listen to thousands of local and global online radio programs. You can also manually add new radio stations.

Direct audio output

Turn your Turbo vNAS into a complete music system by connecting USB speakers for direct audio output.



The free Qmusic mobile app allows you to listen to your complete music collection anytime and anywhere. Scan the QR Code to download!



Photo Station

Centralized management

All of your photos, including RAW photos, can be centrally managed with the Photo Station.

Photo captions

Adding captions for photos can aid in search. For example, you can manually add the date to selected photos and make them part of your timeline.

Review photos on Google Maps

Retrace the steps of your photos by geo-tagging them and creating a map of your photo albums in Google Maps.

Private collection

Create a protected private collection of personal photos & videos that can only be accessed by you.

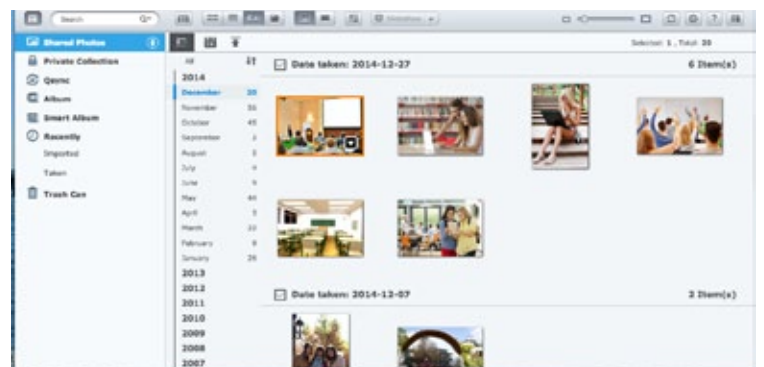

Play by slideshows

Create attractive slideshows using photos and music stored on your Turbo vNAS.

Group photo sharing

Share photos in groups by saving them in Team Folders in your Qsync folder, and allows people with access rights to the Team Folders to browse those photos in their Photo Station.



Download Station

Your 24/7 download center

Once you finish managing download tasks, just turn off your computer and they will keep downloading until they are finished.

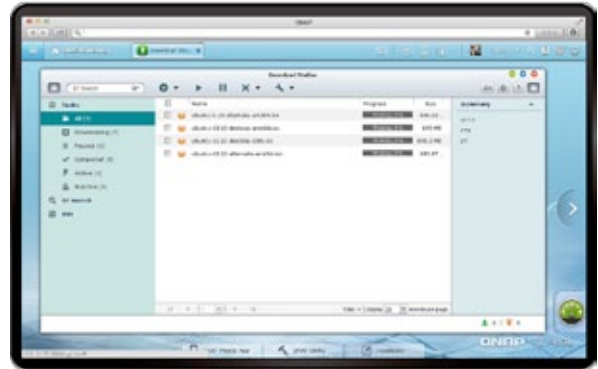

Powerful BT search engine

Easily find and add files to your download list with the built-in search engine.

Wide range of supported downloads

Supports downloading from BT, PT, Magnet, FTP/FTPS, HTTP/HTTPS and RSS.

Third-party Development Platform

With its open-source Linux kernel, QTS is a friendly development platform that allows software developers to create all kinds of applications. Developers can also enjoy a more efficient R&D process with the backup, security, cloud storage tools, and reliable Turbo vNAS hardware design.

Dedicated customer service, sales and R&D support

QNAP Turbo vNAS applications can be developed using the following three approaches:

Development Toolkit (API & SDK):

Developers can use the QNAP Development Toolkit (API & SDK) to design applications that run on client devices (such as smartphones and PCs) to remotely manage and access files stored on their Turbo vNAS.

NAS App (QPKG)

Development:

Developers can design add-ons/apps for the Turbo vNAS and have them seamlessly integrate with data stored on the same platform. Developers can also distribute their apps via the QTS App Center.

VM Integration:

Depending on your OS needs, you can use VM integration to install an alternative OS to run non-Linux-based applications on the Turbo vNAS.

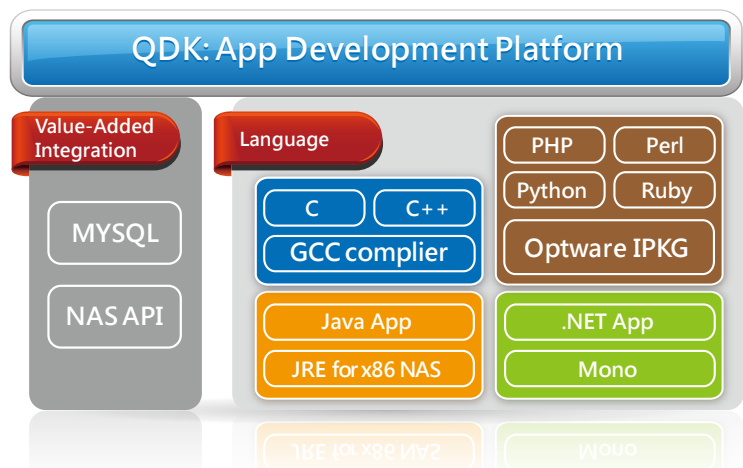



Hardware Introduction

The TVS-ECx80+ Edge Cloud Turbo vNAS series is ideal for deployment in the data center for building hybrid cloud storage. This Turbo vNAS series offers advantages in hardware design and reduced price, bringing a breakthrough level of price/performance.

▶ Intel® Xeon® E3-1245 v3 3.4GHz/ Intel® Core™ i3 Processors

The TVS-ECx80+ Turbo vNAS series (including the TVS-EC1080+, TVS-EC1080 and TVS-EC880) is powered by a quad-core Intel® Xeon® E3-1245 v3 3.4GHz processor or above, providing 10-bay and 8-bay storage capacity; An economical model (TVS-EC1080-i3) is also available and is equipped with an Intel® Core™ i3-4150 processor and can accommodate 10 hard drives. The flagship model TVS-EC1080+ features 32GB DDR3 RAM and inbuilt dual 10GbE ports, delivering superior performance in its class with up to 2,000 MB/s throughput & 223,000 IOPS. The built-in 256GB mSATA modules can further enhance NAS performance for IOPS-demanding applications.

TVS-EC1080+

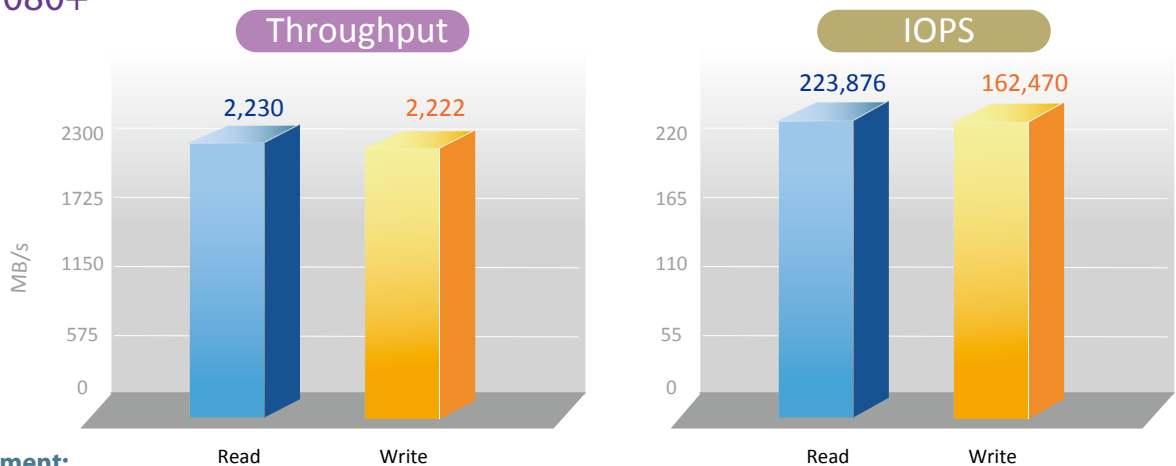

Test Environment:

2 Client PC: Intel® Core™ i7-2600 CPU, 16GB DDR3 RAM, Windows 7 professional 64-bit, Dual-port Intel X520 10GbE Server Adapter, IOMeter sequential read and write.

NAS: OCZ Vertex4 VTX4-25SAT3-128G SSDs with RAID 6 configuration, QNAP LAN-10G2T-D dual-port 10GBase-T network adapter*1
Tested in QNAP Lab. Figures could vary by environment.

▶ SSD cache acceleration

The TVS-EC1080+ series supports SSD caching options (including two internal mSATA modules and 4 SSDs) to improve the overall workflow of IOPS-demanding applications such as virtualization and data center deployment. The SSD caching can be easily utilized and managed with the QTS Storage Manager. The SSD cache adopts the Read Cache with Write Through algorithm and can greatly improve random read performance and ensure data security.



The TVS-EC1080+ comes with two inbuilt mSATA modules; mSATA modules can be purchased optionally and installed on other models. Besides installing the mSATA modules, SSD caching can also be achieved by installing SSDs in the hard drives.

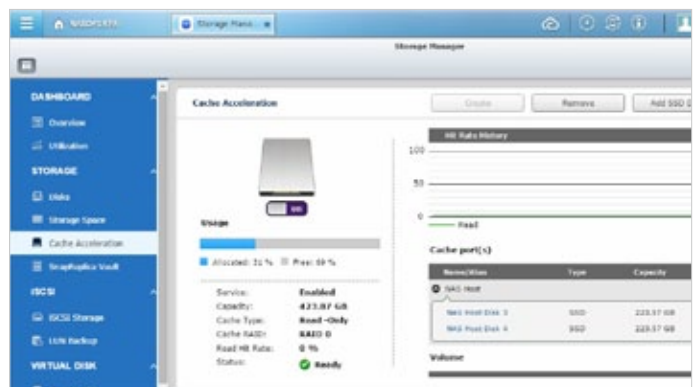

➤ QNAP superb hardware design

To keep the hard disks to run smoothly even under the heaviest load, the QNAP Turbo vNAS features enhanced thermal and mechanical design to dissipate heat more effectively. In addition, the handle of the hard drive tray has a lock to prevent the HDDs from slipping out. And the sheet metal alongside the tray is employed for electromagnetic shielding.

Excellent thermal and mechanical design for efficient heat dissipation

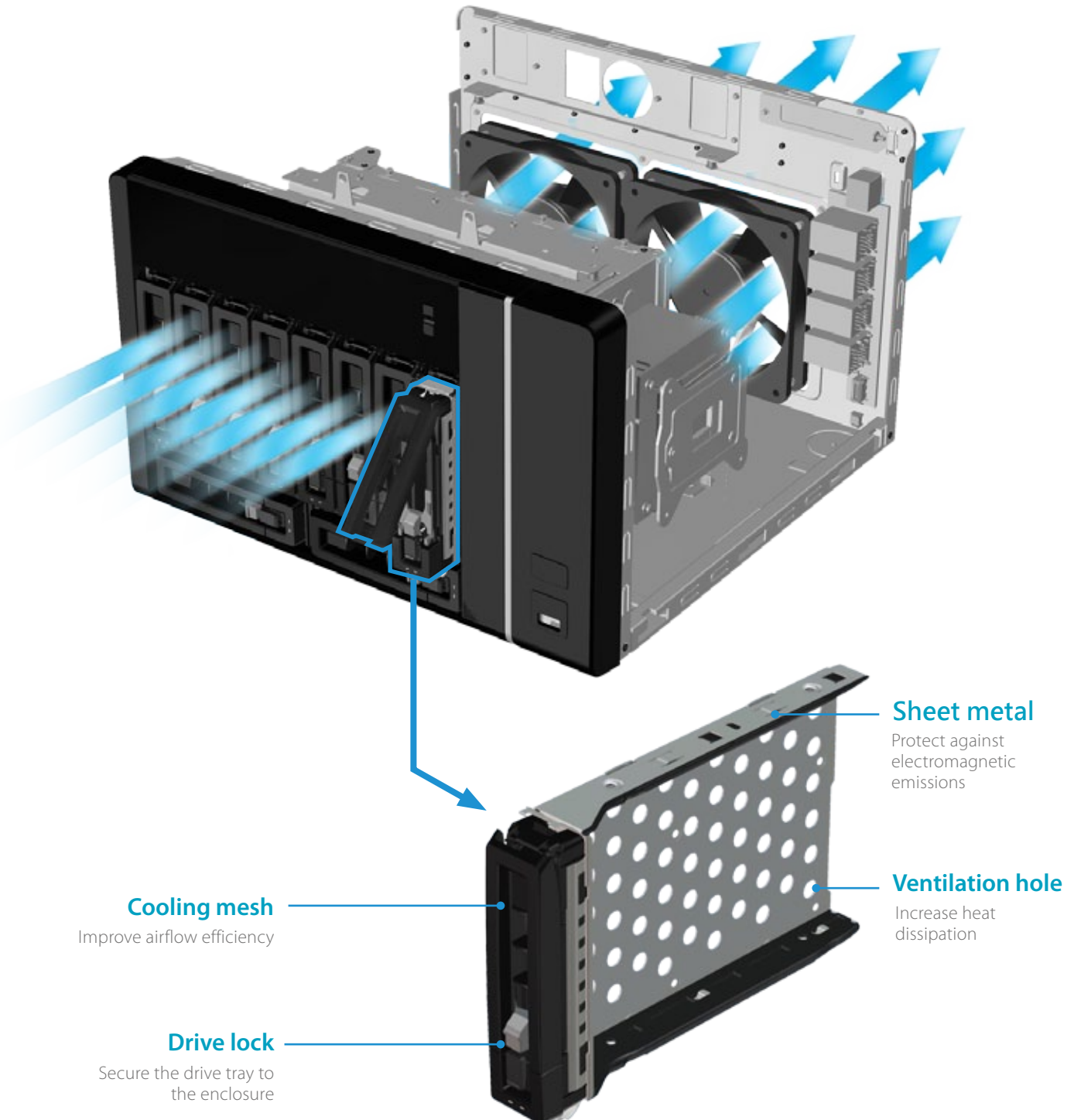



Hardware Introduction

PCI-E expansion slot

The TVS- ECx80+ series has an internal PCI-E Gen3 x8 slot. You can install a 10GbE network adapter to increase network speed or a SAS expansion card to expand storage capacity.

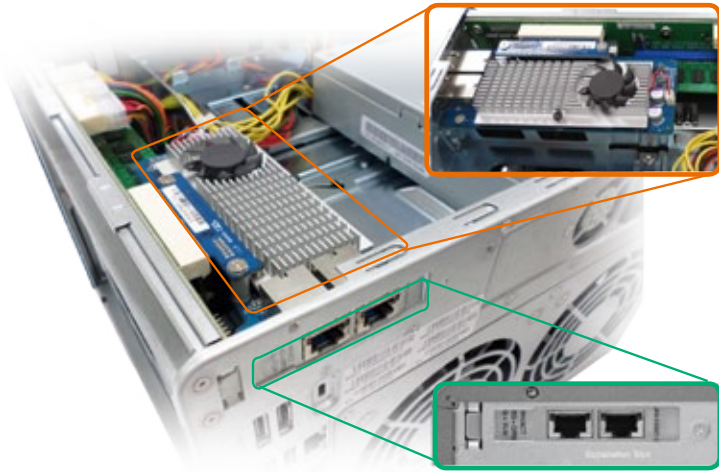

High-speed 10GbE LAN

The TVS- ECx80+ series includes 4 built-in Gigabit Ethernet ports and provides the opportunity to install an additional 10GbE adapter. Excellent hardware design coupled with tremendous capacity makes the TVS- ECx80+ series ideal for supporting video creation and editing directly over the network as well as saving all media files in the workflow.

The advantages of the TVS-ECx80+ series:

1. High network transmission speed
2. High IOPS
3. Reduced system response time



You can optionally purchase 10GbE network adaptors to bring 10 times the bandwidth of Gigabit Ethernet to increase data service velocity.

Media production workflow in a 10GbE network environment

Digital film and video production produces volumes of data that require high performance RAID storage with sustainable throughput to balance with the demanding output of video editing. The TVS-ECx80+ series fulfills storage and video editing needs with a high-speed 10GbE network interface. QNAP Turbo vNAS is dedicated shared storage for collaborative workflow in high-resolution multimedia projects on different file systems, achieved by supporting a variety of file sharing protocols such as NFS, AFT and SMB/CIFS. Furthermore, the scalable design of the Turbo vNAS allows for the capacity to be expanded on the fly so the Turbo vNAS can grow as the business data does.

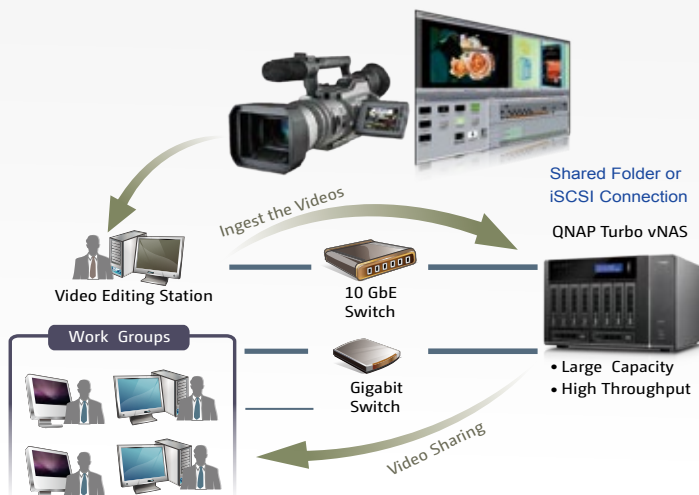

REXP-1000 Pro SAS 6Gbps Expansion Units

The Turbo vNAS supports capacity expansion by connecting multiple QNAP expansion enclosures via mini-SAS cables. With the QNAP scale-up solution, the raw capacity of the Turbo vNAS can be expanded up to 400TB. This is especially useful for large data applications, such as video surveillance, data archiving, and TV broadcast storage.



➤ Online capacity expansion

Simply connect the REXP-1000 Pro to the Turbo vNAS to scale up Turbo vNAS storage instantly. The Turbo vNAS will automatically detect the hard drives in the REXP-1000 Pro as newly installed local drives. With the QTS Storage Manager, the Turbo vNAS capacity can then be expanded as a large volume seamlessly.



➤ Missing mode protection

If your REXP-1000 Pro is accidentally disconnected, the Turbo vNAS enters missing mode and blocks I/O access to protect the stored data. The system can then recover from the missing mode to the normal state with data remaining intact.

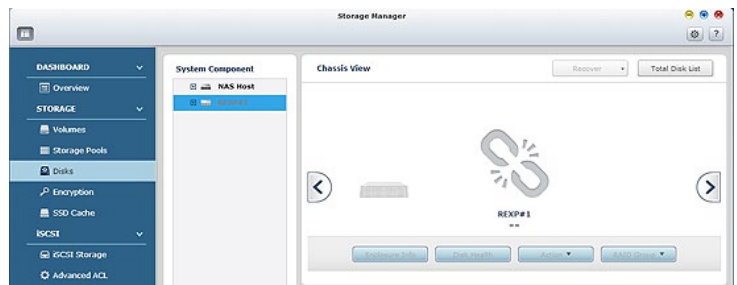

➤ SAS/SATA 6Gbps HDDs and SSDs

The REXP-1000 Pro offers high flexibility in hard drive selection. IT administrators can choose enterprise-level SAS HDDs with high performance and high reliability for mission critical applications, low-cost but high-capacity SATA HDDs for large data archiving, or high-speed and high stability SSDs for I/O intensive operations.

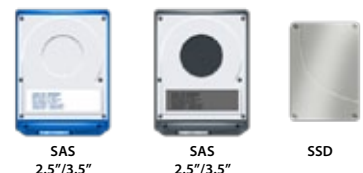

The maximum raw storage capacity available by connecting QNAP expansion enclosures:

Turbo vNAS Model	Max. number of REXP-1000 Pro	Total HDD No. (NAS+Expansion Units)	Max. Raw Capacity*
TVS-EC1080+-E3			
TVS-EC1080-E3	4	50 (10+40)	400
TVS-EC1080-i3			
TVS-EC880-E3	4	48 (8+40)	384

* The maximum capacity is calculated by using 8TB hard drives.



Hardware Specifications







	TVS-EC1080+-E3-32G	TVS-EC1080-E3-16G/ TVS-EC1080-E3-8G	TVS-EC1080-i3-8G	TVS-EC880-E3-16G/ TVS-EC880-E3-8G
CPU	Intel® Xeon® E3-1245 v3 (3.4 GHz) Quad-Core Processor or above		Intel® Core™ i3-4150 (3.5 GHz) Dual-Core Processor or above	Intel® Xeon® E3-1245 v3 (3.4 GHz) Quad-Core Processor or above
Memory (RAM)	32 GB DDR3 RAM	TVS-EC1080-E3-16G : 16 GB DDR3 TVS-EC1080-E3-8G : 8 GB DDR3 Expandable : up to 32 GB (8GB x4)	8 GB DDR3 RAM Expandable : up to 32 GB (8GB x4)	TVS-EC880-E3-16G : 16 GB DDR3 RAM TVS-EC880-E3-8G : 8 GB DDR3 RAM Expandable : up to 32 GB (8GB x4)
Flash	512MB DOM			
Internal Cache Slot	Build-in 256 GB (128 GB x2) mSATA Cache	2 mSATA cache slots (The standard system is shipped without mSATA flash)		
Internal Hard Drive	10 x 2.5" or 3.5" SATA 6Gb/s, 3Gb/s HDDs/SSDs			8 x 2.5" or 3.5" SATA 6Gb/s, 3Gb/s HDDs/SSDs
Hard Drive Tray	10 x Hot-swappable and lockable tray			8 x Hot-swappable and lockable tray
10GbE Network Adapter	Two 10GBASE-T ports (pre-installed with a QNAP LAN-10G2T-D 10GBASE-T network	Yes (optional purchase)		
Gigabit LAN Ports	4 x Gigabit RJ-45 Ethernet port			
LED Indicators	Status, 10GbE, LAN, USB, eSATA			
USB 3.0/2.0	3/6			
Buttons	Power, Reset			
Dimensions	217.5(H) x 327(W) x 321.2(D) mm 8.56(H) x 12.8(W) x 12.65(D) inch			
Weight	Net weight (NAS only): 12.52 kg/27.61 lb Gross weight (with packing and accessories): 19.75 kg/43.54 lb			
Noise Level (dB)	Standby: 30.4 dB; In Operation: 31.6 dB			
Power Consumption (W)	Sleep mode: 68W; In Operation: 130W			
Temperature	0-40°C			
Humidity	5~95% non-condensing, wet bulb: 27°C			
Power Supply Specification	Input: 100-240V AC, 50-60Hz, Output: 350W			
Expansion Slots	1* PCIe Gen3 x8 (Pre-installed a dual-port 10GbE network card)	1* PCIe Gen3 x8		
Fan	2 x 12 cm smart cooling fan			

Accessories





Category	Order P/N	Description
RAID Expansion Enclosure	 REXP-1000 Pro	Tower 10-bay RAID expansion enclosure
SAS Card	 SAS-6G2E-D	Dual-wide-port storage expansion card, SAS 6Gbps, for tower model, desktop bracket
LAN Card	 LAN-1G2T-D	Dual-port 1GbE network expansion card tower model, desktop bracket
mSATA Flash	 FLASH-256GB-MSATA	128 GB mSATA flash module x 2
RAM	 RAM-4GDR3-LD-1600	4GB DDR3 RAM, 1600MHz, long-DIMM
	 RAM-8GDR3-LD-1600	8GB DDR3 RAM, 1600MHz, long-DIMM
Cable	 CAB-SAS10M-8088	MiniSAS external cable (SFF-8088 to SFF-8088), 1.0m
	 CAB-SAS05M-8088	MiniSAS external cable (SFF-8088 to SFF-8088), 0.5m

All specifications are subject to change without notice.
For more information, please go to www.qnap.com



10GbE network adapter compatibility list 10GBASE-T Interface

Category	Order P/N	Description
QNAP	 LAN-10G2T-D	QNAP dual-port 10 Gigabit Network Expansion Card for Tower Model (10GBASE-T interface)
	 LAN-10G1T-D	QNAP single-port 10 Gigabit Network Expansion Card for Tower Model (10GBASE-T interface)
Emulex	 Oce11102-NT	Dual-port 10GbE network expansion card for rackmount models, cat6A cable
Intel	 X520-T2 (E10G42BT)	Dual-port 10GbE network expansion card for tower models, desktop bracket, cat6A cable

SFP+ OPTIC Interface

Category	Order P/N	Description
QNAP	 LAN-10G1SR	QNAP single-port 10 Gigabit Network Expansion Card for Tower Model (10G SFP+ interface)
Emulex	 Oce11102-NM	Dual-port 10 Gigabit network adapter, short range optical cable
	 Oce11102-IM	
Intel	 X520-SR2 (10G42BFSR)	

SFP+ DAC (Direct Attach Copper) Interface

Category	Order P/N	Description
Emulex	 Oce11102-NX	Dual port 10 Gigabit network adapter, SFP+ direct attach copper cable
	 Oce11102-IX	
Intel	 X520-DA2 (E10G42BTDA)	



Software Specifications

Operating System

- QTS 4.1.2 (embedded Linux)

Supported Clients

- Windows XP, Vista, Windows 7 (32/64-bit), Windows 8 (32/64-bit), Windows Server 2003/2008 R2/2012, Apple Mac OS X, Linux & UNIX

Supported Browsers

- Google Chrome
- Microsoft Internet Explorer 10+
- Mozilla Firefox 8+
- Apple Safari

Multilingual Support

- Chinese (Traditional & Simplified), Czech, Danish, Dutch, English, Finnish, French, German, Greek, Hungarian, Italian, Japanese, Korean, Norwegian, Polish, Portuguese (Brazil), Romanian, Russian, Spanish, Swedish, Thai, Turkish

File System

- Internal Hard Drive: EXT4
- External Hard Drive: EXT3, EXT4, NTFS, FAT32, HFS+

Networking

- TCP/IP (IPv4 & IPv6: Dual Stack)
- Quad Gigabit NICs with jumbo frame (failover, multi-IP settings, port trunking/NIC teaming)
- Service binding based on network interfaces
- Proxy server (Squid available in App Center)
- Proxy client
- DHCP client, DHCP server
- Protocols: CIFS/SMB, AFP (v3.3), NFS(v3), FTP, FTPS, SFTP, TFTP, HTTP(S), Telnet, SSH, iSCSI, SNMP, SMTP, and SMC
- UPnP & Bonjour Discovery
- USB Wi-Fi Adapter Support

Security

- Network access protection with auto-blocking: SSH, Telnet, HTTP(S), FTP, CIFS/SMB, AFP
- CIFS host access control for shared folders
- FIPS 140-2 validated AES 256-bit volume-based data encryption*
- AES 256-bit external drive encryption*
- Importable SSL certificates
- Instant alert via e-mail, SMS, beep, and LCD panel
- * SomeThe data encryption functions may not available in accordance with the legislative restrictions of some countries.

Storage Management

- QNAP flexible Volume/LUN with thin provisioning and space reclaim
- RAID 0,1, 5, 6, 10, + hot spare
- Supports storage pool
- Online volume expansion
- Online storage pool expansion
- Online RAID capacity expansion and online RAID level migration
- SMART data migration
- Storage expansion via QNAP REXP-1000 Pro expansion unit
- Bad block scan and hard drive S.M.A.R.T.
- Bad block recovery
- RAID recovery
- Bitmap support

Power Management

- Wake on LAN
- Internal hard drive standby mode
- Scheduled power on/off
- Automatic power on after power recovery
- USB and network UPS support with SNMP management
- System sleep mode (S3)

Access Right Management

- Batch users creation
- Import/export users
- User quota management
- Local user access control for CIFS, AFP, FTP, and WebDAV
- Application access control for Photo Station, Music Station, Video Station, and Multimedia Station
- Subfolder permissions support for CIFS/SMB, AFP, FTP, and File Station

myQNAPcloud Service

- Private cloud storage and sharing with myQNAPcloud id (QID)

- Free host name registration (DDNS)
- Auto router (via UPnP) configuration
- Web-based file manager with HTTPS 2048-bit encryption
- Cloudlink for remote access without complicated router setup
- myQNAPcloud connect for easy VPN connection (Windows VPN utility)

Qsync

- Syncs files among multiple devices with SSL support
- Selective synchronization for syncing specific folders only
- Share team folder as a file center for team collaboration (Maximum sync tasks: 32)
- Shares files by links via email-e-mail
- Policy settings for conflicted files and file type filter support
- Version control: up to 64 versions.
- Incremental synchronization for HDD space saving
- Supports Windows & Mac OS

Web Administration

- Multi-window, multi-tasking based system management
- Movable Icons and personalized desktop
- Smart toolbar and dashboard for neat system status display on system status
- Smart fan Control
- Dynamic DNS (DDNS)
- SNMP (v2 & v3)
- Resource monitor
- Network recycle bin for file deletion via CIFS/SMB, AFP, and File Station
 - Automatic Cleanup
 - File Type Filter
- Comprehensive logs (events & connection)
- Syslog client/server
- System settings backup and restore
- Restore to factory default
- Mobile app: Qmanager for remote system monitoring & management

File Server

- File Sharing across Windows, Mac, and Linux/UNIX
- Windows ACL
- Advanced folder permission for CIFS/SMB, AFP, FTP
- Shared folder aggregation (CIFS/SMB)

FTP Server

- FTP over SSL/TLS (Explicit)
- FTP support
- Passive ftp port range control

File Station

- Supports ISO Mounting (Up to 256 ISO Files)
- Supports thumbnail display of multimedia files
- Supported sharing download links and upload links
- Drag-n-drop Files via Google Chrome and Mozilla Firefox Browsers
- Photo, music, and video preview and playback with hardware-accelerated transcoding
- File Compression (ZIP or 7z)
- Creation of and sending download links for sharing public files with expiration time and password protection
- Support for displaying subtitles display (*.SRT, UTF-8 format)
 - Video seeking support for video playback during on-the-fly transcoding
 - Support slideshow playback in media viewer
- Mobile App: Qfile for file browsing and management)

Backup Station

- Remote replication server (over rsync)
- Real-time remote replication (RTRR) to another QNAP NAS or FTP server
- Works as both RTRR server & client with bandwidth control
- Real-time & scheduled backup
- Encryption, compression, file filter, and transfer rate limitation
- Encrypted replication between QNAP NAS servers
- Desktop backup with QNAP NetBak Replicator for Windows
- Apple Time Machine backup support
- Data backup to multiple external storage devices
- Third party backup software support: Veeam backup & replication, Acronis True Image, Arcserve backup, EMC retrospect, Symantec Backup Exec, etc.

Cloud Storage Backup

- Amazon S3
- Amazon Glacier
- WebDAV-based cloud storage
- Microsoft Azure
- Open Stack
- Google Drive
- Dropbox
- ElephantDrive
- Symform

Print Server

- Max. number of printers: 3
- Support for Internet Printing Protocol
- Print job display and management
- IP-based and domain name-based privilege control

Virtualization Station

- Support Virtual Machine (VM) creation to run an operating system such as Windows, Linux, Unix and Android
- Support importing VM from the other virtual platform, e.g. VirtualBox, VMware Workstation
- Support exporting VM with *.ovf, *.qvm formats
 - VM clone
 - VM snapshot
- HTML5-based shared remote console
- User-based permission setting
- Support USB device pass-through
- Support VM console display via HDMI

HD (HybridDesk) Station 2.0

- Playbacks videos, music, photos on you TV tv with XBMC xbmc via HDMI hdmi output
- Watch various online contents such as YouTube, Flickr, Picasa, Shoutcast, and more, etc.
- Web browser (Chrome, Firefox)
- Supports USB U.S. keyboard and mouse
- Supports QNAP Qremote app and the official XBMC remote app
 - 4 new desktop themes
 - Supports user login permissions

Signage Station

- Supports dynamic content includings videos, images, music, and text messages
- Supports multi- users collaboration
- Supports searching via keywords,
- Supports sharing via email and social networks sharing
- Supports design software - iArtist Lite
- Supports account authority management
- Supports various web browsers for playback (Chrome, Firefox, IE, Safari)
- Supports most- viewed, latest- released and different categories content list

iSCSI (IP SAN)

- iSCSI target with multi-LUNs per target (Up to 256 targets/LUNs combined)
- Support for LUN mapping & masking
- Online LUN capacity expansion
- Support for SPC-3 persistent reservation
- Support for MPIO & MC/S
- iSCSI LUN backup, one-time snapshot, and restoration
- iSCSI connection and management by QNAP Windows Qfinder
- Virtual disk drive (via iSCSI initiator)
- Stack chaining master
- Max No. of virtual disk drives: 8

Server Virtualization & Clustering

- Server Virtualization & Clustering
 - VMware vSphere (ESXi 5.x)
 - VMware VAAI for iSCSI and VAAI for NAS
- vSphere Plug-in
- Citrix XenServer (6.2)
- Windows Server 2012 R2 Hyper-V
- Supports Microsoft ODX
- QNAP SMI-S provider for Microsoft SCVMM

Surveillance Station

- Supports over 2,100 IP ip cameras
- Includes 8 free camera licenses, up to 80 camera channels via additional license purchase
- Instant playback to check the recent events
- Online editing to change edit cameras when in live view
- Visual aid by using e-maps
- Playback and speed control by shuttle bar
- Video preview using on playback timeline
- Intelligent Video Analytics (IVAiva) for advanced video search
- Surveillance client for Mac

- Mobile surveillance app: Vmobile (iOS and Android)
- Mobile recording app: Vcam (iOS and Android)

Notes Station

- Graphical web-based editor for taking notes
- Integrate with NAS file system: insert attachment or image from NAS file system
- Event calendar and to-do list
- Image editor: a easy way to highlight the focus in your image
- Support note publishing with a single link
- Support key word search
- Provide Chrome Extension: Notes Station Clipper
- Clip web page content to your note
- Mobile app: Quotes

VPN Server

- Secure remote access: PPTP & OpenVPN VPN services
- Max number of clients: 30

VPN Client

- Supported VPN protocols: PPTP & OpenVPN services
- PPTP Authentication: PAP, CHAP, MS-CHAP, MS-CHAPv2
- PPTP Encryption: None, AES 40/128 bit, AES 256 bit
- OpenVPN Encryption: None, AES 40/128 bit, AES 256 bit
- Transmission package monitor
- OpenVPN port control
- OpenVPN link compression

Domain Authentication Integration

- Microsoft Active Directory (AD)
- Domain controller
- LDAP server, LDAP client
- Domain users login via CIFS/SMB, AFP, FTP, and File Station

AirPlay & Chromecast

- Streams videos, photos and music from the NAS to Apple TV via Qfile or QAirPlay&Chromecast's web-based controller
- Streams videos, photos and music from the NAS to TV with a Chromecast dongle via Qfile , Qvide or QAirPlay&Chromecast's web-based controller

App Center

- More than 100 official and community software add-ons (ex: Dropbox, Google Drive Sync, McAfee, WordPress, HappyGet II, etc.)
- Photo Station
- Music Station
- Video Station
- iTunes Server
- DLNA Server
- AirPlay: Streams videos, photos and music from NAS to Apple TV via Qfile or QAirPlay's web-based controller
- Digital TV Station
- Download Station
- HD Station + XBMC media player + Google Chrome

Mobile Apps

- Qfile: iOS, Android, Windows Phone 8+
- Qfile HD: iPad version
- Qmanager: iOS, Android
- Qmusic: iOS, Android
- Qremote: iOS, Android
- Qget: Android
- Vmobile: iOS, iPad, Android

PC Utilities

- Qfinder: Windows, Mac, Linux
- myQNAPcloud Connect: Windows
- Qsync: Windows, Mac
- NetBak Replicator: Windows
- QGet: Windows, Mac, Linux
- vSphere Client plug-in: Windows
- Qsnap: Windows

Design and specifications are subject to change without notice.



TVS-ECx80+ Edge Cloud Turbo vNAS Series

10GbE-ready NAS with Comprehensive Business Applications

▶ QvPC (Virtualized PC) Technology

Use your NAS as a PC to run multiple Windows, Linux, UNIX and Android-based VMs and monitor Surveillance Station in real time with local display via HDMI.

▶ 4K Hardware-accelerated Transcoding

Play 4K videos with 7.1 audio passthrough and transcode 4K and 1080p videos in real-time or offline to universal formats with hardware-accelerated transcoding.

▶ Efficient IT Management

Centrally manage multi-site Turbo NAS for monitoring system logs, and managing firmware update and maintenance easily and efficiently with Qcenter.

▶ Unified Storage, Backup & Sharing

Provides a secure storage solution for data backup, file sharing and virtualization applications, coupled with hardware-accelerated AES-256-bit Full NAS volume encryption for ensured security.



Flagship Model TVS-EC1080+-E3-32G
TVS-EC1080-E3-16G / TVS-EC1080-E3-8G
TVS-EC1080-i3-8G

TVS-EC880-E3-16G / TVS-EC880-E3-8G



QNAP Systems, Inc.

TEL : +886-2-2641-2000 FAX : +886-2-2641-0555 Email: qnapsales@qnap.com
Address : 3F, No.22, Zhongxing Rd., Xizhi Dist., New Taipei City, 221, Taiwan

QNAP may make changes to specification and product descriptions at any time, without notice.
Copyright © 2015 QNAP Systems, Inc. All rights reserved.

QNAP® and other names of QNAP Products are proprietary marks or registered trademarks of QNAP Systems, Inc. Other products and company names mentioned herein are trademarks of their respective holders.

Intel Core, Xeon, the Intel logo, and combinations thereof are trademarks of Intel Corporation in the U.S. and/or other countries.

Netherlands (Warehouse Services)

Email : nlsales@qnap.com
TEL : +31(0)107600830

Germany

Email : desales@qnap.com
TEL : +49-89-381562991

China

Email : cnsales@qnap.com.cn
TEL : +86-400-628-0079

India

Email : indiasales@qnap.com

US

Email : usasales@qnap.com
TEL : +1-909-595-2782

Thailand

Email : thsales@qnap.com
TEL : +66-2-5415988



P/N: 51000-023760-RS
201501 (EN) B