



VPD-142/VPD-142N

VPD-143/VPD-143N

Features

- Excellent C/P ratio (cost/performance)
- High-resolution color touch screen
- RTC (Real Time Clock)
- Multiple serial communication interfaces
- Rubber Keypad (VPD-142/VPD-143)
- GUI design
- Free HMIWorks development tool
- Supports the C programming language and Ladder Designer
- ESD Protection: 4 kV
- Front Panel: IP65 Waterproof
- I/O Expansion Boards (XV-Boards)
- Supports the Modbus TCP/RTU communication protocol
- Supports the custom communication protocol(C language)



Introduction

VPD industrial touch HMI device series features, 4.3" high resolution color touch screen LCD. With touchscreen capability, it is easy to deploy into all kinds of automation systems, and make them more intuitive and efficient. Either setup new system installations or complete system retrofits, VPD series stands out for its wide variety of communication methods. Its built-in communication ports include RS-232/RS-485, and Ethernet, USB interface, enable integration into the system allowing users to control, monitor I/O at the remote sides and update firmware directly from the central computer. Besides, the built-in non-volatile storage makes VPD series more reliable for rugged environments.

HMIWorks, the free development software for VPD series, provides an easy-to-use environment, and powerful and intuitive programming with graphic capabilities to let users create appealing graphical interface screens in minutes. For PLC users, HMIWorks provides Ladder Designer and C language environment for IT users. Especially, it only takes no more than 30 minutes to learn how to create an application program when using Ladder Designer. With all the features provided, VPD series touch HMI Devices must be the most cost effective HMI Device ever been in the market.

Applications



VPD-142/VPD-142N /VPD-143/ VPD-143N with DIN-Rail Mounting

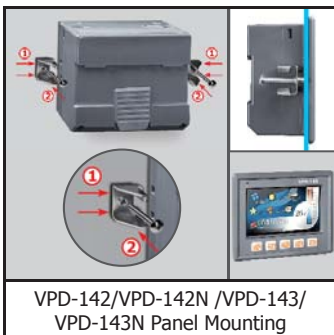

VPD-142/VPD-142N /VPD-143/ VPD-143N Panel Mounting

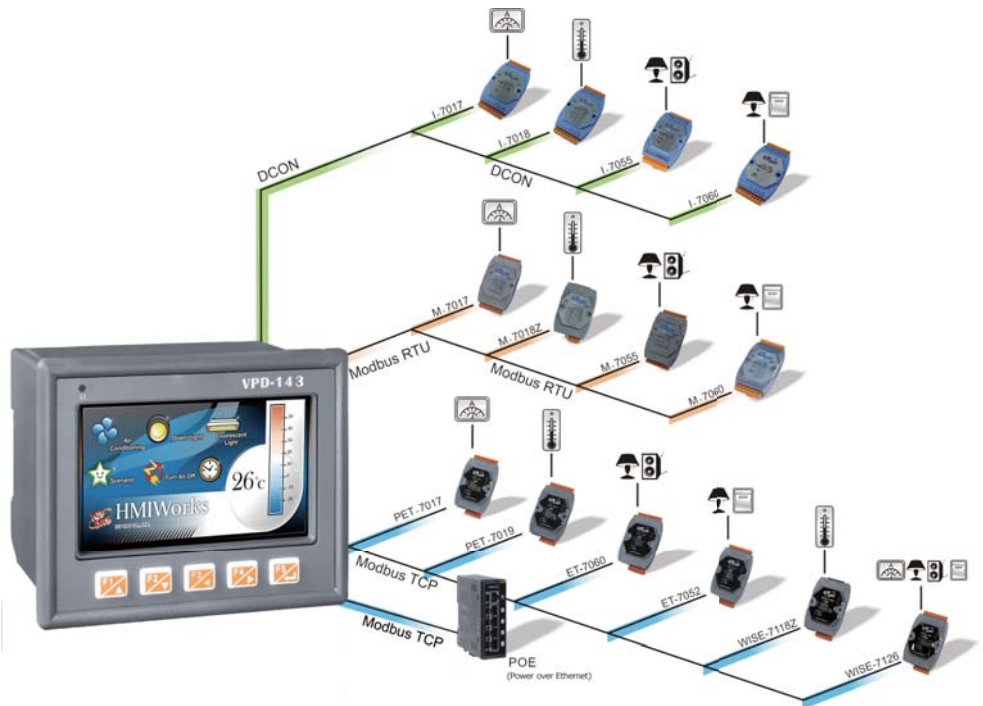

Applications

Status Display

Presentations

Factory/Machine Automation

User-defined HMI

Power Monitor

- Voltage (V)
- Current (A)
- Power (W)
- Power Factor

Schedule Management with Built-in RTC

Multi-display

Multi-page Design

	Time	Shutdown	Cumulative Time
1	120 _m	Start	120 _m Reset
2	120 _m	Start	120 _m Reset
3	120 _m	Start	

	Remaining
1	120 _m
2	120 _m
3	120 _m

26c

curr. val. 2010/03/23 11:25:25

Specifications

Models	VPD-142	VPD-142N	VPD-143	VPD-143N
CPU Module				
CPU	32-bit RISC CPU			
Memory Expansion	16 MB SDRAM / 8 MB Flash			
Real Time Clock (RTC)	Yes			
Buzzer	Yes			
Rotary Switch (0~9)	Yes			
Communication Interface				
Serial Port 1	One set of RS-232 (3-pin) / RS-485 (including Self-Tuner)			
Serial Port 2	One set of RS-232 (3-pin) / RS-485 (including Self-Tuner)			
USB 1.1 Client	Firmware updates only			
Ethernet	-		RJ-45 x 1, 10/100 Base-TX	
I/O Expansion				
I/O Expansion Bus	Yes, One of XVboards			
MMI (Main Machine Interface)				
LCD	4.3" TFT(Resolution 480 X 272 X 16), defective pixels <= 3			
Backlight Life	20,000 hours			
Brightness	400 cd/m2			
LED Indicator	Yes			
Touch Panel	Yes			
Reset Button	Yes			
Rubber Keypad	5 keys (Programmable)	-	5 keys (Programmable)	-
Electrical				
Powered from Terminal Block	+12 ~ 48 Vdc			
Powered from PoE	-		IEEE 802.3af, Class1 (48 V)	
Power Consumption	2.5 W			
Mechanical				
Dimensions (W x L x H)	131 mm x 105 mm x 54 mm			
Ingress Protection	Front Panel: IP65			
Installation	DIN-Rail Mounting and Panel Mounting			
Environmental				
Operating Temperature	-20 ~ +50°C			
Storage Temperature	-30 ~ +80°C			
Ambient Relative Humidity	10 ~ 90% RH, non-condensing			





Appearance

VPD-142/VPD-143 Front View



VPD-142N/VPD-143N Front View



DIO Board					
Model	XV107	XV107A	XV110	XV111	XV111A
Image					
Digital Input					
Channel	8	8	16		
Contact	Wet	Wet	Dry+Wet		
Sink/Source (NPN/PNP)	Source	Sink	Sink/Source		
Wet Contact	On Voltage Level	+10 VDC ~ +50 VDC			
	Off Voltage Level	+4 VDC Max.			
Dry Contact	On Voltage Level	-	Close to GND		
	Off Voltage Level	-	Open		
Counters	Max. Count	65535 (16-bit)			
	Max. Input Frequency	100 Hz			
	Min. Pulse Width	5 ms			
Input Impedance	10 K Ω				
Oversvoltage Protection	70 Vdc				
Intra-module Isolation, Field to Logic	3750 Vdc				
Digital Output					
Channel	8			16	
Type	Open Collector	Open Emitter		Open Collector	Open Emitter
Sink/Source (NPN/PNP)	Sink	Source		Sink	Source
Load Voltage	+3.5 Vdc ~ 50 Vdc	+10 Vdc ~ 40 Vdc		+3.5 Vdc ~ 50 Vdc	+10 Vdc ~ 40 Vdc
Max. Load Current	700 mA/channel			600 mA/channel	
Overload Protection	1.4 A			1.4 A	
Intra-module Isolation, Field to Logic	3750 VDC			3750 VDC	
Power Requirements					
Consumption	0.2 W		0.6 W	0.3 W	

Relay output Board		
Model	XV116	
Image		
Relay Output		
Channel	6	
Type	Form A (SPST N.O.)	
Operating Voltage Range	250 VAC or 30 Vdc	
Max. Load Current	Relay 0 ~ 1: 2 A Relay 2 ~ 5: 4 A	
Operating Time	Relay 0 ~ 1: 4 ms Max. Relay 2 ~ 5: 5 ms Max.	
Release Time	Relay 0 ~ 1: 6 ms Max. Relay 2 ~ 5: 1 ms Max.	
Mechanical Life	Relay 0 ~ 1: 100 x 10 ⁶ cycles Relay 2 ~ 5: 30 x 10 ⁶ cycles	
On-Resistance	-	
Off-State Leakage Current	-	
Intra-module Isolation, Field to Logic	3750 Vdc	
Digital Input		
Channel	5	
Contact	Wet	
Sink/Source (NPN/PNP)	Sink/Source	
Wet Contact	On Voltage Level	+10 Vdc ~ 50 Vdc
	Off Voltage Level	+4 Vdc Max.
Input Impedance	10 K Ω	
Overvoltage Protection	60 Vdc	
Intra-module Isolation, Field to Logic	3750 Vdc	
Power Requirements		
Consumption	1W	

Multifunction Board		
Model	XV308	
Image		
Analog Input		
Channel	8	
Wiring	Single-Ended	
Sensor Type	+/- 1 V, +/- 2.5 V, +/- 5 V, +/- 10 V, 0 ~ 20 mA, 4 ~ 20 mA, +/-20 mA (Jumper selectable)	
Resolution	Normal Mode	14-bit
	Fast Mode	12-bit
Sampling Rate	Normal Mode	10 Hz
	Fast Mode	200 Hz
Input Impedance	10 M Ω	
Overvoltage Protection	120 Vdc	
Overcurrent Protection	1000 mA	
Isolation	2500 Vdc	
Digital Input		
Channel	4	
Contact	Dry	
Sink/Source (NPN/PNP)	Source	
Wet Contact	On Voltage Level	Close to GND
	Off Voltage Level	Open
Overload Protection	30 Vdc	
Digital Output		
Channel	4	
Type	Open Collector	
Sink/Source (NPN/PNP)	Sink	
Load Voltage	+10 Vdc ~ +50 Vdc	
Max. Load Current	700 mA/Channel	
Overload Protection	1.4 A	
Power Requirements		
Consumption	1 W	

Dimensions (Units: mm)

VPD-142/VPD-143

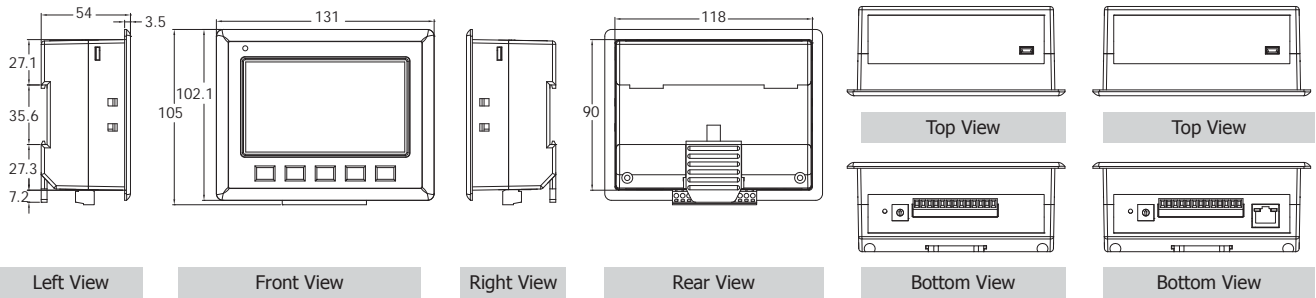

Left View

Front View

Right View

Rear View

VPD-142

VPD-143

Top View

Top View

Bottom View

Bottom View

VPD-142N/VPD-143N

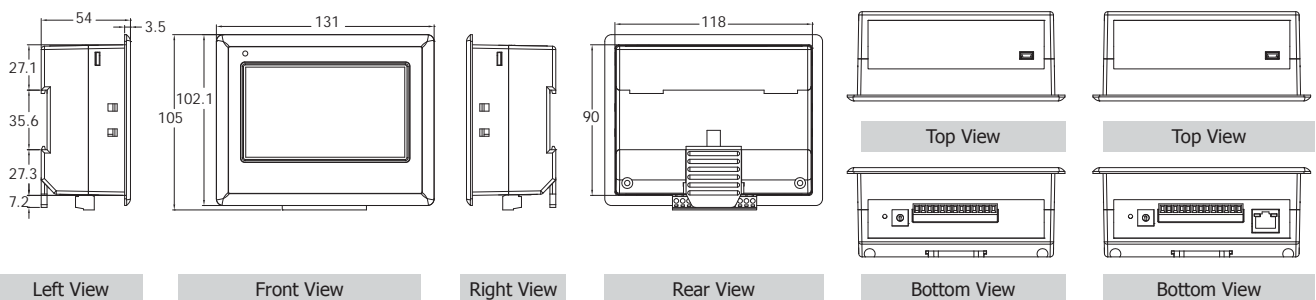

Left View

Front View

Right View

Rear View

VPD-142N

VPD-143N

Top View

Top View

Bottom View

Bottom View

VPD-142/VPD-142N/VPD-143/VPD-143N

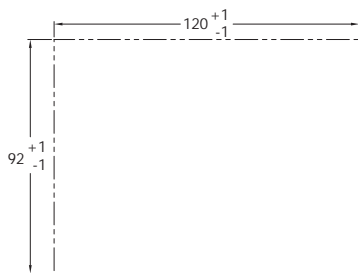

Recommended Panel Cutout

Pin Assignments

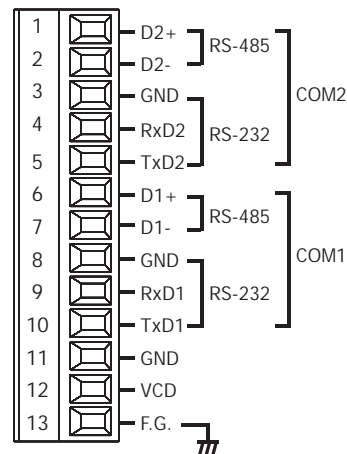

VPD-142/VPD-142N/VPD-143/VPD-143N



Ordering Information

VPD-142 CR	4.3" Touch HMI device with RS-232/RS-485, USB, RTC, Rubber Keypad, support XV-board (RoHS)
VPD-142N CR	4.3" Touch HMI device with RS-232/RS-485, USB, RTC, support XV-board (RoHS)
VPD-143 CR	4.3" Touch HMI device with Ethernet, RS-232/RS-485, USB, RTC, Rubber Keypad, support XV-board (RoHS)
VPD-143N CR	4.3" Touch HMI device with Ethernet, RS-232/RS-485, USB, RTC, support XV-board (RoHS)

Accessories

 CA-USB10	USB to 5P Mini-USB, 28AWG, 1.5 m
 MDR-60-24 CR	24 VDC/2.5A, 60 W Power Supply with DIN-Rail Mounting (RoHS)
 DIN-KA52F CR	24 VDC/1.04 A, 25 W Power Supply with DIN-Rail Mounting (RoHS)